

***myprojectorlamps.com***

**The most trusted, dependable name  
in projector lamp sales.**



<http://www.myprojectorlamps.com>



<http://www.myprojectorlamps.ca>



<http://www.myprojectorlamps.eu>

The following projector manual has not been modified or altered in any way.

# ***DUKANE***

## **LCD Projector**

### **Model 8915**

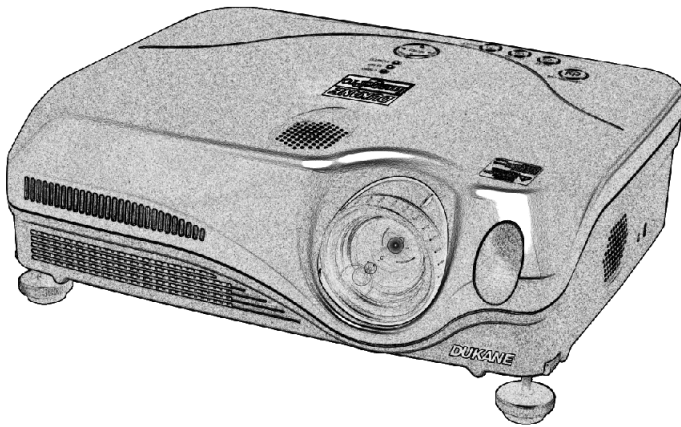

## **User's Manual**



# DUKANE

Projector

## User's Manual - Safety Guide

---



Thank you for purchasing this projector.

**⚠ WARNING** • Before using, read these user's manuals of this projector to ensure correct usage through understanding. After reading, store them in a safe place for future reference. Incorrect handling of this product could possibly result in personal injury or physical damage. The manufacturer assumes no responsibility for any damage caused by mishandling that is beyond normal usage defined in these manuals of this projector.

- NOTE** • The information in this manual is subject to change without notice.
- The manufacturer assumes no responsibility for any errors that may appear in this manual
  - The reproduction, transmission or use of this document or contents is not permitted without express written authority.

### About The Symbols

Various symbols are used in this manual, the user's manual and on the product itself to ensure correct usage, to prevent danger to the user and others, and to prevent property damage. The meanings of these symbols are described below. It is important that you read these descriptions thoroughly and fully understand the contents.

|   |                |  |
|---|----------------|--|
|    | <b>WARNING</b> | This symbol indicates information that, if ignored, could possibly result in personal injury or even death due to incorrect handling.      |
|  | <b>CAUTION</b> | This symbol indicates information that, if ignored, could result possibly in personal injury or physical damage due to incorrect handling. |

### Typical Symbols



This symbol indicates an additional warning (including cautions). An illustration is provided to clarify the contents.



This symbol indicates a prohibited action. The contents will be clearly indicated in an illustration or nearby (the symbol to the left indicates that disassembly is prohibited).



This symbol indicates a compulsory action. The contents will be clearly indicated in an illustration or nearby (the symbol to the left indicates that the power plug should be disconnected from the power outlet).

# Safety Precautions

## WARNING

### **Never use the projector if a problem should occur.**

Abnormal operations such as smoke, strange odor, no image, no sound, excessive sound, damaged casing or elements or cables, penetration of liquids or foreign matter, etc. can cause a fire or electrical shock.

In such case, immediately turn off the power switch and then disconnect the power plug from the power outlet. After making sure that the smoke or odor has stopped, contact your dealer. Never attempt to make repairs yourself because this could be dangerous.

- The power outlet should be close to the projector and easily accessible.

### **Use special caution for children and pets.**

Incorrect handling could result in fire, electrical shock, injury, burn or vision problem.

Use special caution in households where children and pets are present.

### **Do not insert liquids or foreign object.**

Penetration of liquids or foreign objects could result in fire or electrical shock. Use special caution in households where children are present.

If liquids or foreign object should enter the projector, immediately turn off the power switch, disconnect the power plug from the power outlet and contact your dealer.

- Do not place the projector in a bathroom.
- Do not expose the projector to rain or moisture.
- Do not place flower vases, pots, cups, cosmetics, liquids such as water, etc on or around the projector.
- Do not place metals, combustibles, etc on or around the projector.
- To avoid penetration of foreign objects, do not put the projector into a case or bag together with any thing except the accessories of the projector, signal cables and connectors.

### **Never disassemble and modify.**

The projector contains high voltage components. Modification and/or disassembly of the projector or accessories could result in fire or electrical shock.

- Never open the cabinet.
- Ask your dealer to repair and clean insides.

### **Do not give the projector any shock or impact.**

If the projector should be shocked and/or broken, it could result in an injury, and continued use could result in fire or electrical shock.

If the projector is shocked, immediately turn off the power switch, disconnect the power plug from the power outlet and contact your dealer.

### **Do not place the projector on an unstable surface.**

If the projector should be dropped and/or broken, it could result in an injury, and continued use could result in fire or electrical shock.

- Do not place the projector on an unstable, slant or vibrant surface such as a wobbly or inclined stand.
- Use the caster brakes placing the projector on a stand with casters.
- Do not place the projector in the side up position, the lens up position or the lens down position.
- In the case of a ceiling installation or the like, contact your dealer before installation.



Disconnect the plug from the power outlet.



Do not disassemble.



# Safety Precautions (continued)

## **WARNING**

### **Be cautious of High temperatures of the projector.**

High temperatures are generated when the lamp is lit. It could result in fire or burn. Use special caution in households where children are present.

Do not touch about the lens, air fans and ventilation openings during use or immediately after use, to prevent a burn. Take care of ventilation.

- Keep a space of 30 cm or more between the sides and other objects such as walls.
- Do not place the projector on a metallic table or anything weak in heat.
- Do not place anything about the lens, air fans and ventilation openings of the projector.
- Do not use with the ventilation opening facing downwards.
- Never block the air fan and ventilation openings.
- Do not cover the projector with a tablecloth, etc.
- Do not place the projector on a carpet or bedding.



### **Never look through the lens or openings when the lamp is on.**

The powerful light could adversely affect vision.

Use special caution in households where children are present.



### **Use only the correct power cord and the correct power outlet.**

Incorrect power supply could result in fire or electrical shock.

- Use only the correct power outlet depending on the indication on the projector and the safety standard.
- The enclosed power cord must be used depending on the power outlet to be used.



### **Be cautious of the power cord connection.**

Incorrect connection of the power cord could result in fire or electrical shock.

- Do not touch the power cord with a wet hand.
- Check that the connecting portion of the power cord is clean (with no dust), before using. Use a soft and dry cloth to clean the power plug.
- Insert the power plug into a power outlet firmly. Avoid using a loose, unsound outlet or contact failure.



### **Be sure to connect with ground wire.**

Connect the ground terminal of AC inlet of this unit with the ground terminal provided at the building using the correct power cord; otherwise, fire or electric shock can result.

- Don't take the core of power cord away.



Surely connect the ground wire.

# Safety Precautions (continued)

## **WARNING**

### **Be careful in handling the light source lamp.**

The projector uses a high-pressure mercury glass lamp made of glass. The lamp can break with a loud bang, or burn out. When the bulb bursts, it is possible for shards of glass to fly into the lamp housing, and for gas containing mercury to escape from the projector's vent holes.



### **Please carefully read the section "Lamp".**

### **Be careful in handling the power cord and external connection cables.**

If you keep using a damaged the power cord or cables, it can cause a fire or electrical shock. Do not apply too much heat, pressure or tension to the power cord and cables.

If the power cord or cables is damaged (exposed or broken core wires, etc.), contact your dealer.

- Do not place the projector or heavy objects on the power cord and cables. Also, do not place a spread, cover, etc, over them because this could result in the inadvertent placing of heavy objects on the concealed power cord or cables.



- Do not pull the power cord and cables. When connecting and disconnecting the power cord or cables, do it with your hand holding the plug or connector.

- Do not place the cord near the heater.

- Avoid bending the power cord sharply.

- Do not attempt to work on the power cord.

### **Be careful in handling the battery of the remote control.**

Incorrect handling of the battery could result in fire or personal injury. The battery may explode if not handled properly.

- Keep the battery away from children and pets. If swallowed consult a physician immediately for emergency treatment.

- Do not allow the battery in a fire or water.

- Avoid fire or high-temperature environment.

- Do not hold the battery with the metallic tweezers.

- Keep the battery in a dark, cool and dry play.

- Do not short circuit the battery.

- Do not recharge, disassemble or solder the battery.

- Do not give the battery a physical impact.

- Use only the battery specified in the other manual of this projector.

- Make sure the plus and minus terminals are correctly aligned when loading the battery.

- If you observe a leakage of the battery, wipe out the flower and then replace the battery. If the flower adheres your body or clothes, rinse well with water.

- Obey the local laws on disposing the battery.



# Safety Precautions (continued)

## CAUTION

### **Be careful in moving the projector.**

Neglect could result in an injury or damage.

- Do not move the projector during use. Before moving, disconnect the power cord and all external connections, and close the slide lens door or attach the lens cap.
- Avoid any impact or shock to the projector.
- Do not drag the projector.
- For moving the projector, use the enclosed case or bag if provided.



### **Do not put anything on top of the projector.**

Placing anything on the projector could result in loss of balance or falling, and cause an injury or damage. Use special caution in households where children are present.



### **Do not attach anything other than specified things to the projector.**

Neglect could result in an injury or damage.

- Some projector has a screw thread in a lens part. Do not attach anything other than specified options (such as conversion lens) to the screw thread.



### **Avoid a smoky, humid or dusty place.**

Placing the projector in a smoke, a highly humid, dusty place, oily soot or corrosive gas could result in fire or electrical shock.

- Do not place near the smoking space, the kitchen or a humidifier.



### **Take care of the air filter to normal ventilate.**

The air filter should be cleaned periodically. If the air filter becomes clogged by dust or the like, internal temperature rises and could cause malfunction. The projector may display the message such as “CHECK THE AIR FLOW” or turn off the projector, to prevent the internal heat level rising.

- When the indicators or a message prompts you to clean the air filter, clean the air filter as soon as possible.
- If the soiling will not come off the air filter, or it becomes damaged, replace the air filter.
- Use the air filter of the specified type only. Please order the air filter specified in the other manual of this projector to your dealer.
- When you replace the lamp, replace also the air filter. The air filter may be attached when you buy a replacement lamp for this projector.
- Do not turn on the projector without air filter.



### **Avoid a high temperature environment.**

The heat could have adverse influence on the cabinet of the projector and other parts. Do not place the projector, the remote control and other parts in direct sunlight or near a hot object such as heater, etc.



### **Remove the power cord for complete separation.**

- For safety purposes, disconnect the power cord if the projector is not to be used for prolonged periods of time.
- Before cleaning, turn off and unplug the projector. Neglect could result in fire or electrical shock.



Disconnect the plug from the power outlet.



# Safety Precautions (continued)

## CAUTION

**Ask your dealer to cleaning inside of the projector about every two years.**

Accumulations of dust inside the projector cause result in fire or malfunction. Cleaning inside is more effective if performed before every humid periods such as rainy season.



- Do not clean inside yourself because it is dangerous.

## NOTE

**Do not give the remote control any physical impact.**

A physical impact could cause damage or malfunction of the remote control.

- Take care not to drop the remote control.
- Do not place the projector or heavy objects on the remote control.

**Take care of the lens.**

- Close the slide lens door or attach the lens cap to prevent the lens surface being scratched when the projector is not used.
- Do not touch the lens to prevent fog or dirt of the lens that cause deterioration of display quality.
- Use commercially available lens tissue to clean the lens (used to clean cameras, eyeglasses, etc.). Be careful not to scratch the lens with hard objects.

**Take care of the cabinet and the remote control.**

Incorrect care could have adverse influence such as discoloration, peeling paint, etc.

- Use a soft cloth to clean the cabinet and control panel of the projector and the remote control. When excessively soiled dilute a neutral detergent in water, wet and wring out the soft cloth and afterward wipe with a dry soft cloth. Do not use undiluted detergent directly.
- Do not use an aerosol sprays, solvents, volatile substances or abrasive cleaner.
- Before using chemical wipes, be sure to read and observe the instructions.
- Do not allow long-term close contact with rubber or vinyl.

**About bright spots or dark spots.**

Although bright spots or dark spots may appear on the screen, this is a unique characteristic of liquid crystal displays, and such do not constitute or imply a machine defect.

**Be careful of printing of the LCD panel.**

If the projector continues projecting a still image, inactive images or 16:9 aspect images in case of 4:3 panel, etc., for long time, the LCD panel might possibly be printed.

In such a case, please make the projector project a whole white screen for 1 hour or more. You can use the BLANK function of the projector.

**About consumables.**

Lamp, LCD panels, polarizers and other optical components, and air filter and cooling fans have a different lifetime in each. These parts may need to be replaced after a long usage time, even if one year has not passed since the beginning of using. For more details, please consult your dealer.

# Safety Precautions (continued)

## NOTE

### **Avoid strong rays.**

Any strong ray (such as direct rays of the sun or room lighting) onto the remote control sensors could invalidate the remote control.

### **Avoid radio interference.**

Any interfering radiation could cause disordered image or noises.

- Avoid radio generator such as a mobile telephone, transceiver, etc. around the projector.

### **About displaying characteristic.**

The display condition of the projector (such as color, contrast, etc.) depends on characteristic of the screen, because the projector uses a liquid crystal display panel. The display condition can differ from the display of CRT.

- Do not use a polarized screen. It can cause red image.

### **Turn the power on/off in right order.**

To prevent any trouble, turn on/off the projector in right order mentioned below unless specifying.

- Power on the projector before the computer or video tape recorder.
- Power off the projector after the computer or video tape recorder.

### **Take care not to fatigue your eyes.**

Rest the eyes periodically.

### **Set the sound volume at a suitable level to avoid bothering other people.**

- It is better to keep the volume level low and close the windows at night to protect the neighborhood environment.

### **Connecting with notebook computer**

When connecting with notebook computer, set to valid the RGB external image output (setting CRT display or simultaneous display of LCD and CRT).

Please read instruction manual of the notebook for more information.

# Lamp



## WARNING



HIGH VOLTAGE



HIGH TEMPERATURE



HIGH PRESSURE

The projector uses a high-pressure mercury glass lamp. The lamp can **break with a loud bang, or burn out**, if jolted or scratched, handled while hot, or worn over time. Note that each lamp has a different lifetime, and some may burst or burn out soon after you start using them. In addition, when the bulb bursts, it is possible for **shards of glass** to fly into the lamp housing, and for **gas containing mercury** to escape from the projector's vent holes.

**About disposal of a lamp** • This product contains a mercury lamp; do not put in trash. Dispose of in accord with environmental laws.

For lamp recycling, go to [www.lamprecycle.org](http://www.lamprecycle.org). (in USA)

For product disposal, contact your local government agency or [www.eiae.org](http://www.eiae.org) (in the US) or [www.epsc.ca](http://www.epsc.ca) (in Canada).

For more information, call your dealer.



Disconnect the plug from the power outlet

- If the lamp should break (it will make a loud bang when it does), unplug the power cord from the outlet, and make sure to request a replacement lamp from your local dealer. Note that shards of glass could damage the projector's internals, or cause injury during handling, so please do not try to clean the projector or replace the lamp yourself.
- If the lamp should break (it will make a loud bang when it does), ventilate the room well, and make sure not to breathe the gas that comes out of the projector vents, or get it in your eyes or mouth.
- Before replacing the lamp, make sure the power switch is off and the power cable is not plugged in, then wait at least 45 minutes for the lamp to cool sufficiently. Handling the lamp while hot can cause burns, as well as damaging the lamp.



- Do not open the lamp cover while the projector is suspended from above. This is dangerous, since if the lamp's bulb has broken, the shards will fall out when the cover is opened. In addition, working in high places is dangerous, so ask your local dealer to have the lamp replaced even if the bulb is not broken.
- Do not use the projector with the lamp cover removed. At the lamp replacing, make sure that the screws are screwed in firmly. Loose screws could result in damage or injury.



- Use the lamp of the specified type only.
- If the lamp breaks soon after the first time it is used, it is possible that there are electrical problems elsewhere besides the lamp. If this happens, contact your local dealer or a service representative.
- Handle with care: jolting or scratching could cause the lamp bulb to burst during use.
- If the indicators or a message prompts you to replace the lamp (see the section "Related Messages" and "Regarding the indicator Lamps"), replace the lamp as soon as possible. Using the lamp for long periods of time, or past the replacement date, could cause it to burst. Do not use old (used) lamps; this is a cause of breakage.

# Regulatory Notices

## **FCC Statement Warning**

**WARNING:** This equipment has been tested and found to comply with the limits for a Class B digital device, pursuant to Part 15 of the FCC Rules. These limits are designed to provide reasonable protection against harmful interference in a residential installation. This equipment generates, uses, and can radiate radio frequency energy and, if not installed and used in accordance with the instructions, may cause harmful interference to radio communications. However, there is no guarantee that interference will not occur in a particular installation. If this equipment does cause harmful interference to radio or television reception, which can be determined by turning the equipment off and on, the user is encouraged to try to correct the interference by one or more of the following measures:

- Reorient or relocate the receiving antenna.
- Increase the separation between the equipment and receiver.
- Connect the equipment into an outlet on a circuit different from that to which the receiver is connected.
- Consult the dealer or an experienced radio/TV technician for help.

**INSTRUCTIONS TO USERS:** This equipment complies with the requirements of FCC (Federal Communication Commission) equipment provided that the following conditions are met. Some cables have to be used with the core set. Use the accessory cable or a designated-type cable for the connection. For cables that have a core only at one end, connect the core to the projector.

**CAUTION:** Changes or modifications not expressly approved by the party responsible for compliance could void the user's authority to operate the equipment.

## **For the Customers in CANADA**

**NOTICE:** This Class B digital apparatus complies with Canadian ICES-003.

# Warranty And After-Service

Unless seen any abnormal operations (mentioned with the first paragraph of WARNING in this manual), when a problem occurs with the equipment, first refer to the "Troubleshooting" section of the "User's manual – Operating Guide", and run through the suggested checks.

If this does not resolve the problem contact your dealer or service company. They will tell you what warranty condition is applied.



## Projector

ImagePro 8915

# User Manual – Operating Guide

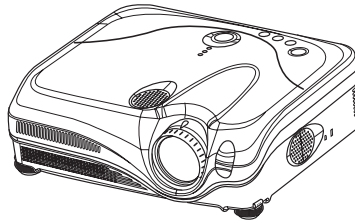

Thank you for purchasing this projector.

**⚠ WARNING** ► Before using, read the "User's Manual - Safety Guide" and these manuals to ensure correct usage through understanding. After reading, store them in a safe place for future reference.

### About this manual

Various symbols are used in this manual. The meanings of these symbols are described below.

**⚠ WARNING** This symbol indicates information that, if ignored, could possibly result in personal injury or even death due to incorrect handling.

**⚠ CAUTION** This symbol indicates information that, if ignored, could result possibly in personal injury or physical damage due to incorrect handling.

 Please refer to the pages written following this symbol.

**NOTE** • The information in this manual is subject to change without notice.

- The manufacturer assumes no responsibility for any errors that may appear in this manual.
- The reproduction, transmission or use of this document or contents is not permitted without express written authority.

### Trademark acknowledgment

- VGA and XGA are registered trademarks of the International Business Machines Corporation.
  - Apple and Mac are registered trademarks of the Apple Computer, Inc.
  - VESA and SVGA are trademarks of the Video Electronics Standard Association.
  - Windows is a registered trademark of the Microsoft Corporation.
  - Internet Explorer is a trademark of the Microsoft Corporation.
  - Netscape is a registered trademark of the Netscape Communications Corporation.
- All other trademarks are the property of their respective owners.

Contents

|  |           |   |   |           |  |
|--|-----------|---|---|-----------|--|
| <b>About this manual</b> . . . . .                 | <b>1</b>  |  | <b>EASY Menu</b> . . . . .  | <b>24</b> |  |
| <b>Contents</b> . . . . .                          | <b>2</b>  |   | Aspect, Mode, Bright, Contrast, Color,<br>Tint, Sharpness, Whisper, Mirror, Reset,<br>Filter time, Language, Go to advanced<br>menu |           |  |
| <b>Projector features</b> . . . . .                | <b>3</b>  |   | <b>PICTURE Menu</b> . . . . .   | <b>26</b> |  |
| <b>Preparations</b> . . . . .                      | <b>3</b>  |   | Bright, Contrast, Gamma, Color temp,<br>Color, Tint, Sharpness, My memory   |           |  |
| About contents of package . . . . .                | 3         |   | <b>IMAGE Menu</b> . . . . .   | <b>29</b> |  |
| Fastening the lens cap . . . . .                   | 3         |   | Aspect, Over scan, V. position, H. phase,<br>H. position, H. size, Auto adjust execute  |           |  |
| <b>Part names</b> . . . . .                        | <b>4</b>  |   | <b>VIDEO Qlty. Menu</b> . . . . .   | <b>31</b> |  |
| Projector . . . . .                                | 4         |   | Progressive, 3D-YCS, Video NR   |           |  |
| Control buttons . . . . .                          | 5         |   | <b>INPUT Menu</b> . . . . .   | <b>32</b> |  |
| Remote control . . . . .                           | 5         |   | Color space, Component, Video format,<br>DVI, Information   |           |  |
| <b>Setting up</b> . . . . .                        | <b>6</b>  |   | <b>SETUP Menu</b> . . . . .   | <b>34</b> |  |
| Arrangement . . . . .                              | 7         |   | Whisper, Mirror, Volume, Stereo, IR remote  |           |  |
| Adjusting the projector's elevator . . . . .       | 8         |   | <b>SCREEN Menu</b> . . . . .  | <b>35</b> |  |
| About the filter cover for bottom-up use . . . . . | 9         |   | Language, Menu position, OSD bright,<br>Blank, Start up, MyScreen,<br>MyScreen lock, Message  |           |  |
| Connecting your devices . . . . .                  | 10        |   | <b>OPTION Menu</b> . . . . .  | <b>38</b> |  |
| Connecting power supply . . . . .                  | 13        |   | One touch, Auto search, Auto off, Lamp<br>time, Filter time, Service  |           |  |
| <b>Remote control</b> . . . . .                    | <b>14</b> |   | <b>NETWORK Menu</b> . . . . .   | <b>40</b> |  |
| Laser pointer . . . . .                            | 14        |   | DHCP, IP address, Subnet mask, Default<br>gateway, Information  |           |  |
| Putting batteries . . . . .                        | 14        |   | <b>Maintenance</b> . . . . .  | <b>44</b> |  |
| Using the remote control . . . . .                 | 15        |   | Lamp . . . . .  | 44        |  |
| <b>Power on/off</b> . . . . .                      | <b>16</b> |   | Air filter . . . . .  | 46        |  |
| Turning on the power . . . . .                     | 16        |   | Other care . . . . .  | 47        |  |
| Turning off the power . . . . .                    | 16        |   | <b>Troubleshooting</b> . . . . .  | <b>48</b> |  |
| <b>Operating</b> . . . . .                         | <b>17</b> |   | Related messages . . . . .  | 48        |  |
| Adjusting the volume . . . . .                     | 17        |   | Regarding the indicator lamps . . . . .   | 50        |  |
| Temporarily muting the sound . . . . .             | 17        |   | Phenomena that may easily be<br>mistaken for machine defects . . . . .  | 52        |  |
| Selecting an input signal . . . . .                | 17        |   | <b>Warranty and after-service</b> . . . . .   | <b>54</b> |  |
| Adjusting screen with ONE-TOUCH . . . . .          | 18        |   | <b>Specifications</b> . . . . .   | <b>54</b> |  |
| Selecting an aspect ratio . . . . .                | 18        |   |   |           |  |
| Adjusting the zoom and focus . . . . .             | 18        |   |   |           |  |
| Using the automatic adjustment feature . . . . .   | 19        |   |   |           |  |
| Adjusting the position . . . . .                   | 19        |   |   |           |  |
| Correcting the keystone distortions . . . . .      | 20        |   |   |           |  |
| Using the magnify feature . . . . .                | 20        |   |   |           |  |
| Freezing the screen . . . . .                      | 21        |   |   |           |  |
| Temporarily blanking the screen . . . . .          | 21        |   |   |           |  |
| Operating the computer screen . . . . .            | 22        |   |   |           |  |
| <b>Multifunctional settings</b> . . . . .          | <b>23</b> |   |   |           |  |
| Using the menu function . . . . .                  | 23        |   |   |           |  |

**Technical (English only)**

(Please see the end of this book, although only in English.)

## Projector features

This projector is used to project various computer signals as well as NTSC/PAL/SECAM video signals onto a screen. It requires just a little space for installation and gets a large image from short distance.

- High Brightness  
Newly developed 230W UHB (Ultra High Brightness) lamp gives you a higher brightness image on a screen. The image can be still kept as bright and clean enough for use in bright rooms.
- Low Noise  
WHISPER mode is equipped for reducing acoustic noise to realize quieter operation. It is perfect for use in low luminance rooms where low noise is more important than brightness.
- Rich Connectivity  
This projector has a variety of I/O ports. It can be easily connected to many signal sources like PC, DVD and so on. The rich connectivity provides you more options to make your presentation impressive.
- Compact Body  
Even with its many features, this projector is extremely compact and slim, which gives you more flexibility and usability to use it where you want.

## Preparations

### About contents of package

Please see the "Contents of package" of the "User's Manual - Quick Guide". Your projector should come with the items shown there. Contact immediately your dealer if anything is missing.

**NOTE** • Keep the original packing materials for future reshipment. For moving the projector, be sure to use the original packing material. Use special caution for the lens part.

### Fastening the lens cap

To avoid losing, please fasten the lens cap to the projector using the strap.

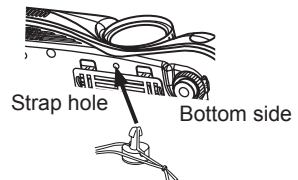
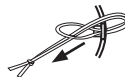
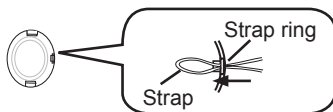

1. Fix the strap to the strap ring of lens cap.
2. Put the strap into the groove on rivet.
3. Push the rivet into the strap hole.



Part names

**Projector**

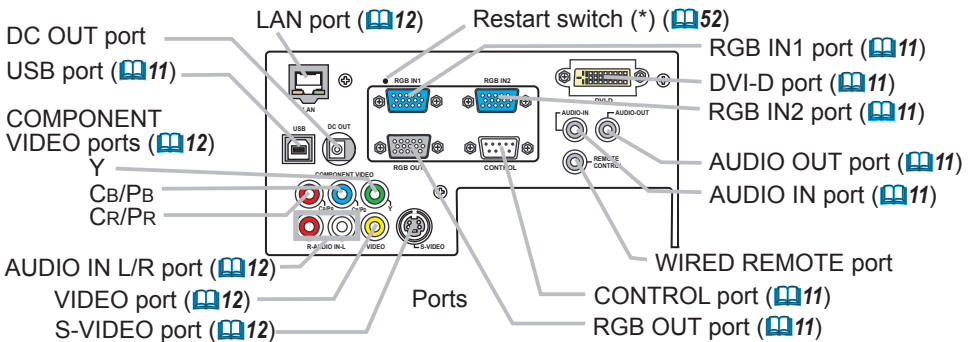
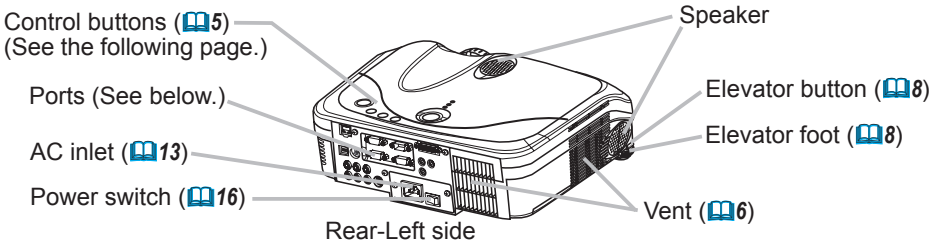
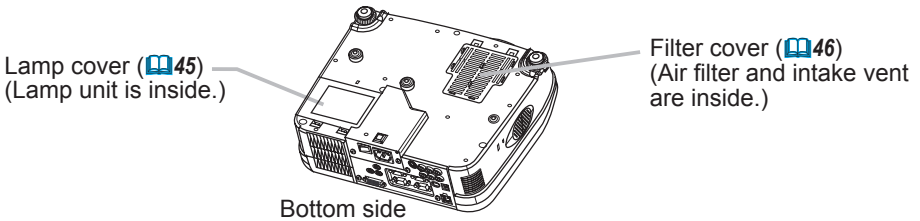
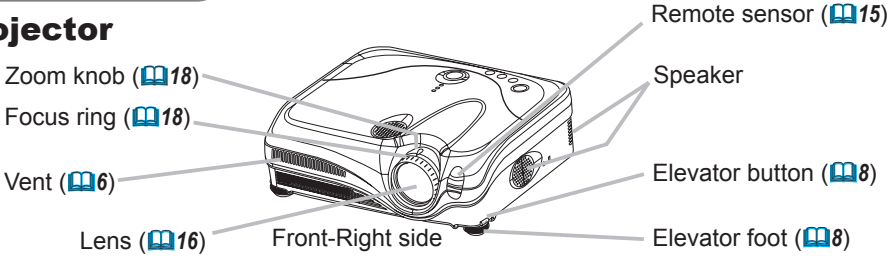

**NOTE (\*) About Restart switch:** This Projector is controlled by an internal microprocessor. Under certain exceptional circumstances, the projector may not operate correctly and the microprocessor will need to be reset. In such a case, please push the Restart switch by using a cocktail stick or similar, and before turning on again, make the projector cool down at least 10 minutes without operating. Only push the Restart switch in these exceptional instances.

## Control buttons

STANDBY/ON button (16)

INPUT button (17)

KEYSTONE button (20)

RESET button (23)

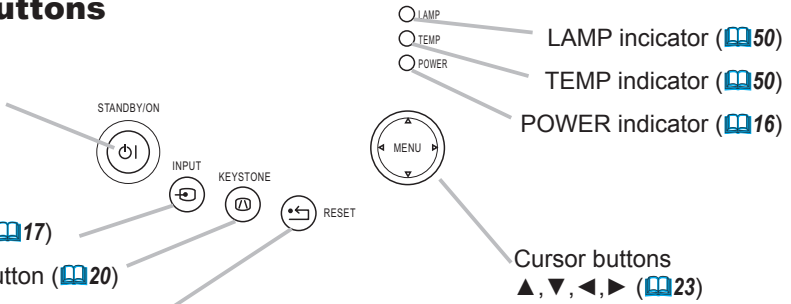

## Remote control

STANDBY/ON button (16)

VIDEO button (17)

BLANK button (21)

ASPECT button (18)

Lever switch (23)

Flip toward disk pad: UP key  
Flip toward MENU button: DOWN key  
Press in center: ENTER

ESC button (22)

POSITION button (19)

MAGNIFY buttons (20)

FREEZE button (21)

KEYSTONE button (20)

Battery cover (14)  
(on the back)

LASER INDICATOR (14)

RGB button (17)

PAGE buttons (22)

LASER button (14)

Disk pad (22)

Right mouse button (22)

CURSOR buttons (23)

RESET button (23)

MENU button (23)

AUTO button (19)

VOLUME button (17)

MUTE button (17)

ONE TOUCH button (18)

REMOTE CONTROL port (15)

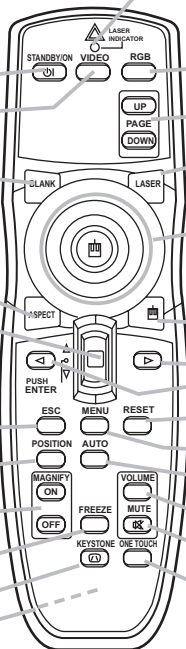

Laser switch (Inside of the battery cover)  
1: enables the laser function  
2: disables the laser function

## Setting up

**⚠ WARNING** ► Place the projector in a stable position horizontally. A fall or a turnover could cause an injury and/or damage to the projector. Then using damaged projector could result in a fire and/or an electric shock.

- Don't place the projector on an unstable, slant or vibrant surface such as a wobbly or inclined stand.
- Do not place the projector in the side/front/rear-up position, except care of the air filter.
- For the projector installed bottom-up, use the accessory filter cover for bottom-up use. And in the case of a ceiling installation or the like, contact your dealer before installation.

► Place the projection in a cool place, and pay attention enough to ventilation. The high temperature of the projector could cause a fire, a burn and/or malfunction to the projector.

- Don't stop up, block and cover the projector's vents.
- Keep a space of 30 cm or more between the sides and other objects such as walls.
- Don't place the projector on a metallic thing or anything weak in heat.
- Don't place the projector on a carpet, cushion or bedding.
- Don't place the projector in direct sunlight or near a hot object such as heater.
- Put nothing about lens and vents of the projector. Put nothing on the projector.
- Put nothing that is sucked or sticks to the bottom of projector. This projector has some intake vents also on the bottom.

► Do not place the projector on the place that gets wet. Damping the projector or inserting liquid in the projector could cause a fire, an electric shock and/or malfunction to the projector.

- Don't place the projector in a bathroom or the outdoors.
- Put nothing containing the liquid near the projector.

**⚠ CAUTION** ► Avoid a smoky, humid or dusty place. Placing the projector in such place could cause a fire, an electric shock and/or malfunction to the projector.

- Don't place the projector near a humidifier, a smoking space or a kitchen.
- Put nothing containing the liquid near the projector.

► Adjust the direction of the projector to keep light from directly hitting the projector's remote sensor.

## Arrangement

Refer to the illustrations and tables below to determine the screen size and projection distance.

The values shown in the table are calculated for a full size screen: 1024 x 768

- (a) The screen size (diagonal)
- (b) Distance from the projector to the screen ( $\pm 10\%$ )
- (c) The height of the screen ( $\pm 10\%$ )

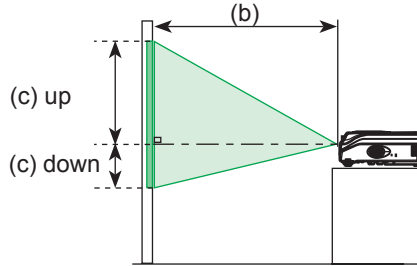
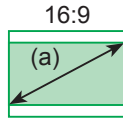
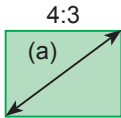

### At 4:3 screen

| (a) Screen size<br>[inch (m)] | (b) Projection distance [m (inch)] |            | (c) Screen height [cm (inch)] |           |
|-------------------------------|------------------------------------|------------|-------------------------------|-----------|
|                               | min.                               | max.       | down                          | up        |
| 30 (0.8)                      | 0.9 (35)                           | 1.1 (42)   | 5 (2)                         | 41 (16)   |
| 40 (1.0)                      | 1.2 (47)                           | 1.4 (57)   | 6 (2)                         | 55 (22)   |
| 50 (1.3)                      | 1.5 (59)                           | 1.8 (71)   | 8 (3)                         | 69 (27)   |
| 60 (1.5)                      | 1.8 (71)                           | 2.2 (86)   | 9 (4)                         | 82 (32)   |
| 70 (1.8)                      | 2.1 (83)                           | 2.6 (100)  | 11 (4)                        | 96 (38)   |
| 80 (2.0)                      | 2.4 (96)                           | 2.9 (115)  | 12 (5)                        | 110 (43)  |
| 90 (2.3)                      | 2.7 (108)                          | 3.3 (130)  | 14 (5)                        | 123 (49)  |
| 100 (2.5)                     | 3.0 (120)                          | 3.7 (144)  | 15 (6)                        | 137 (54)  |
| 120 (3.0)                     | 3.7 (144)                          | 4.4 (174)  | 18 (7)                        | 165 (65)  |
| 150 (3.8)                     | 4.6 (181)                          | 5.5 (217)  | 23 (9)                        | 206 (81)  |
| 200 (5.1)                     | 6.1 (241)                          | 7.4 (291)  | 30 (12)                       | 274 (108) |
| 250 (6.4)                     | 7.7 (302)                          | 9.2 (364)  | 38 (15)                       | 343 (135) |
| 300 (7.6)                     | 9.2 (363)                          | 11.1 (437) | 46 (18)                       | 411 (162) |

### At 16:9 screen

| (a) Screen size<br>[inch (m)] | (b) Projection distance [m (inch)] |            | (c) Screen height [cm (inch)] |           |
|-------------------------------|------------------------------------|------------|-------------------------------|-----------|
|                               | min.                               | max.       | down                          | up        |
| 30 (0.8)                      | 1.0 (38)                           | 1.2 (46)   | -1 (0)                        | 39 (15)   |
| 40 (1.0)                      | 1.3 (51)                           | 1.6 (62)   | -2 (-1)                       | 51 (20)   |
| 50 (1.3)                      | 1.6 (65)                           | 2.0 (78)   | -2 (-1)                       | 64 (25)   |
| 60 (1.5)                      | 2.0 (78)                           | 2.4 (94)   | -2 (-1)                       | 77 (30)   |
| 70 (1.8)                      | 2.3 (91)                           | 2.8 (110)  | -3 (-1)                       | 90 (35)   |
| 80 (2.0)                      | 2.6 (104)                          | 3.2 (126)  | -3 (-1)                       | 103 (41)  |
| 90 (2.3)                      | 3.0 (117)                          | 3.6 (141)  | -4 (-1)                       | 116 (46)  |
| 100 (2.5)                     | 3.3 (131)                          | 4.0 (157)  | -4 (-2)                       | 129 (51)  |
| 120 (3.0)                     | 4.0 (157)                          | 4.8 (189)  | -5 (-2)                       | 154 (61)  |
| 150 (3.8)                     | 5.0 (197)                          | 6.0 (237)  | -6 (-2)                       | 193 (76)  |
| 200 (5.1)                     | 6.7 (263)                          | 8.0 (317)  | -8 (-3)                       | 257 (101) |
| 250 (6.4)                     | 8.4 (329)                          | 10.1 (396) | -10 (-4)                      | 322 (127) |
| 300 (7.6)                     | 10.0 (395)                         | 12.1 (476) | -12 (-5)                      | 386 (152) |

## Adjusting the projector's elevator

**⚠ WARNING** ► Do not adjust the projector's elevator during use or immediately after use. Handling while the projector is in a high temperature could cause a burn and/or malfunction to the projector.

**⚠ CAUTION** ► If you press the elevator button without holding the projector, the projector might crash down, overturn, smash your fingers and possibly result in malfunction. To prevent damaging the projector and injuring yourself, always hold the projector whenever using the elevator buttons to adjust the elevator feet.

► Except for inclining by the elevator feet adjustment, place the projector horizontally.

You can use the elevator feet to make adjustments if the surface on which you need to set the projector is uneven or if you otherwise need to adjust the angle of projection. The adjustment range of the elevator feet is 0 to 9 degrees.

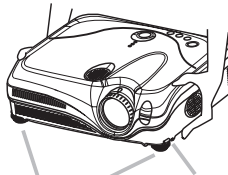

Elevator feet      Elevator button

1. After making sure that the projector is cool adequately, press and hold in the elevator buttons while holding the projector.  
The elevator buttons and the elevator feet are on the both sides.
2. Raise or lower the projector to the desired height and the release the elevator buttons.  
When you release the elevator buttons, the elevator feet will lock into position.
3. As necessary, you can also finely adjust the height of the projector by twisting the elevator feet by hand.

## About the filter cover for bottom-up use

**⚠ WARNING** ▶ Do not replace the filter cover during use or immediately after use. While the projector connects with a power supply, or the projector is in a high temperature state, handling could cause an electric shock, a fire, a burn and/or malfunction to the projector. Before handling, make sure the power switch is off and the power cord is not plugged in, then wait at least 45 minutes.

When the projector is installed bottom up, please use the accessory filter cover for bottom-up use. It is higher than usual filter cover, to keep the space for intake ventilation. Please change in the following procedure.

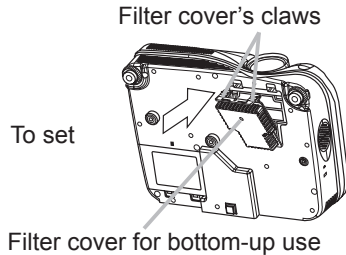
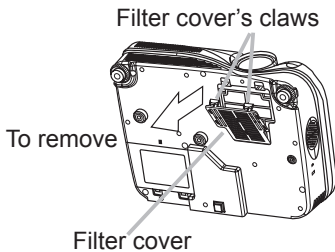

1. After making sure that the projector is cool adequately, slowly turn the projector so that the lens-side is facing up. Please be careful for a projector not to fall. While the projector is placed lens-side up, hold the projector.
2. Unhooking the filter cover's claws, pull the filter cover in the direction of the arrow to remove it.
3. Replace the filter cover for bottom-up use and snap it back into place.
4. Slowly turn the projector so that the top is facing up.

## Connecting your devices

**⚠ CAUTION** ▶ Turn off all devices prior to connecting them to the projector. Attempting to connect a live device to the projector may generate extremely loud noises or other abnormalities that may result in malfunction and/or damage to the device and/or projector.

▶ Use the accessory cable or a designated-type cable for the connection.

Some cables have to be used with core set. A too long cable may cause a certain picture degradation. Please consult with your dealer for details. For cables that have a core only at one end, connect the core to the projector.

▶ Make sure that you connect devices to the correct port. Incorrect connection may result in malfunction and/or damage to the device and/or projector.

**NOTE** • Whenever attempting to connect a laptop computer to the projector, be sure to activate the laptop's RGB external image output (set the laptop to CRT display or to simultaneous LCD and CRT display). For details on how this is done, please refer to the instruction manual of the corresponding laptop computer.

- Secure the screws on the connectors and tighten.
- Some computers may have multiple display screen modes. Use of some of these modes will not be possible with this projector.
- For some RGB signal modes, the optional Mac adapter is necessary.
- When the image resolution is changed on a computer, depending on an input, automatic adjust function may take some time and may not be completed. In this case, you may not be able to see a check box to select "Yes/No" for the new resolution on Windows. Then the resolution will go back to the original. It might be recommended to use other CRT or LCD monitors to change the resolution.

### **About Plug-and-Play capability**

Plug-and-Play is a system composed of the computer, its operating system and peripheral equipment (i.e. display devices). This projector is compatible with VESA DDC 2B. Plug-and-Play can be achieved by connecting this projector to computers that are VESA DDC (display data channel) compatible.

- Please take advantage of this function by connecting the accessory RGB cable to the RGB IN1 port (DDC 2B compatible) and/or the optional DVI cable to the DVI-D port (DDC 2B compatible). Plug-and-Play may not work properly if any other type of connection is attempted.
- Please use the standard drivers in your computer as this projector is a Plug-and-Play monitor.
- The 8915's DVI is compatible with HDCP (High-bandwidth Digital Content Protection) and therefore capable of displaying video from HDCP compatible DVD players, et al. However, if the HDCP standards are modified, the 8915's DVI might not be able to display video from HDCP compatible device developed in conformance to such modified HDCP standards.

Examples of connection with a computer

\* AUDIO IN is linked to RGB IN1/2 and DVI-D.

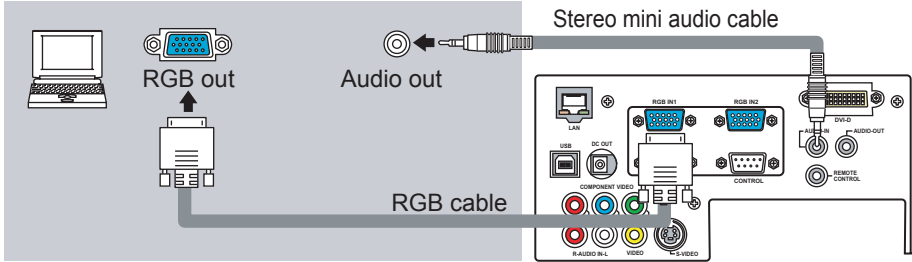
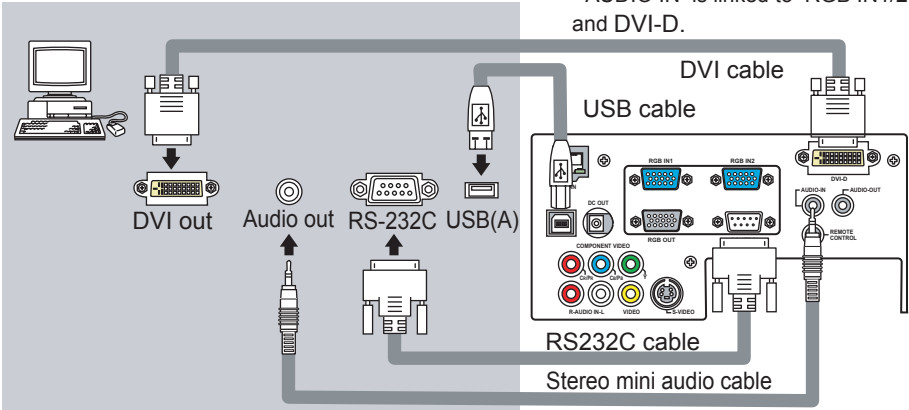

Connecting to a monitor (output)

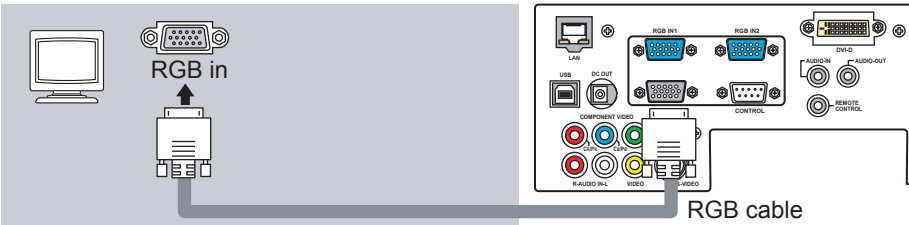

Connecting to a speaker with amplifier (output)

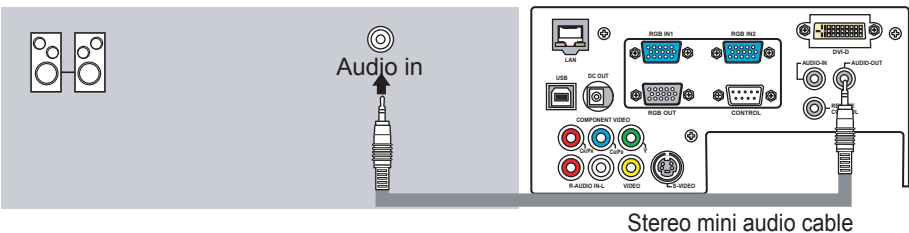



## Examples of connection with a VCR/DVD player

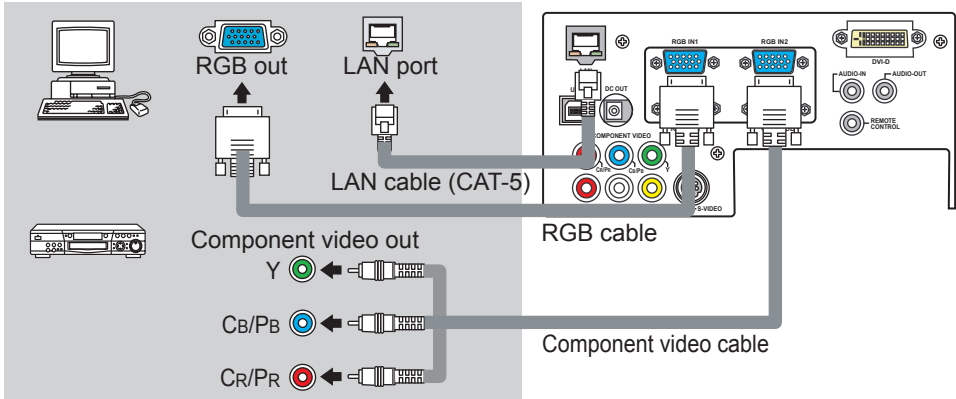
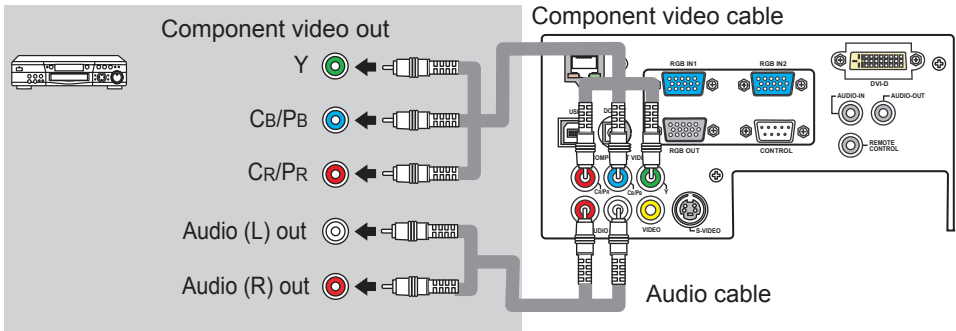
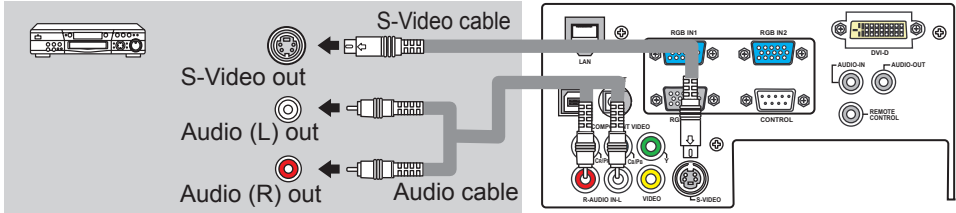
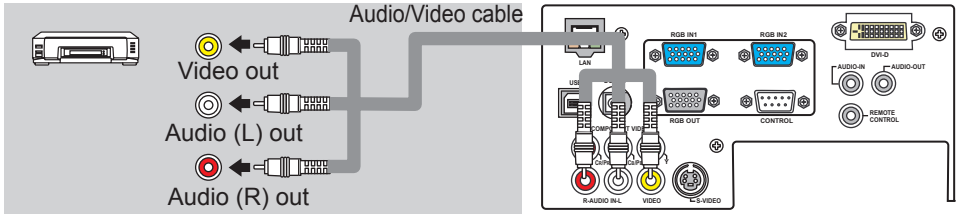

## Connecting power supply

- ⚠ WARNING** ► Please use extra caution when connecting the power cord as incorrect or faulty connections may result in fire and/or electrical shock.
- Only use the power cord that came with the projector. If it is damaged, contact your dealer to newly get correct one.
  - Only plug the power cord into an outlet rated for use with the power cord's specified voltage range.
  - Never modify the power cord. Never attempt to defeat the ground connection of the three-pronged plug.

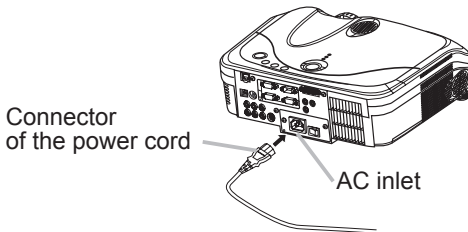

1. Connect the connector of the power cord to the AC inlet of the projector.
2. Firmly plug the power cord's plug into the outlet.

## Remote control

### Laser pointer

**▲WARNING** ▶ The laser pointer of the remote control is used in place of a finger or rod. Never look directly into the laser beam outlet or point the laser beam at other people. The laser beam can cause vision problems.

**▲CAUTION** ▶ Use of controls or adjustments or performance of procedures other than those specified herein may result in hazardous radiation exposure.

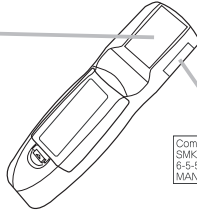

Complies with 21 CFR 1040.10 and 1040.11.  
SMK CORPORATION  
6-5-5 Togoshi Shinagawa-ku, Tokyo, JAPAN 142-8511  
MANUFACTURED June 2002 PLACE OF MANUFACTURER : A

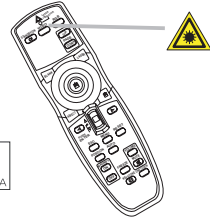

This remote control has a laser pointer in place of a finger or rod. The laser beam works and the LASER INDICATOR lights while the LASER button is pressed.

### Putting batteries

**▲WARNING** ▶ Always handle the batteries with care and use them only as directed. Improper use may result in battery explosion, cracking or leakage, which could result in fire, injury and/or pollution of the surrounding environment.

- Be sure to use only the batteries specified. Do not use batteries of different types at the same time. Do not mix a new battery with used one.
- Make sure the plus and minus terminals are correctly aligned when loading a battery.
- Keep a battery away from children and pets.
- Do not recharge, short circuit, solder or disassemble a battery.
- Do not allow a battery in a fire or water. Keep batteries in a dark, cool and dry place.
- If you observe a leakage of a battery, wipe out the flower and then replace a battery.

If the flower adheres your body or clothes, rinse well with water immediately.

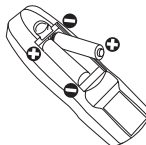
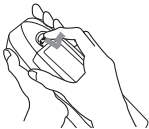

1. Remove the battery cover.  
Slide back and remove the battery cover in the direction of the arrow.
2. Insert the batteries.  
Align and insert the two AA batteries according to their plus and minus terminals as indicated in the remote control.
3. Close the battery cover.  
Replace the battery cover in the direction of the arrow and snap it back into place.

## Using the remote control

**⚠ CAUTION** ▶ Be careful in handling the remote control.

- Do not drop or otherwise expose the remote control to physical impact.
- Do not get the remote control wet or place it on wet objects. Doing so may result in malfunction.
- Remove the batteries from the remote control and store them in a safe place if you won't be using the remote control for an extended period.
- Replace the batteries whenever the remote control starts to malfunction.
- When strong lights, such as direct sunlight or light from an extremely close range (such as from an inverter fluorescent lamp), hit the projector's remote sensor, the remote control may cause to function. Adjust the direction of the projector to keep light from directly hitting the projector's remote sensor.

The remote control works with the projector's remote sensor.

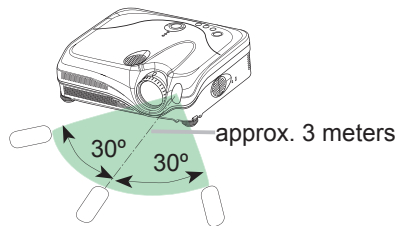

- The range of the remote sensor is 3 meters with a 60-degree range (30 degrees to the left and right of the remote sensor).
- Also a remote signal reflected in the screen etc. may be available. If it is difficult to send a remote signal to the sensor directly, please try.
- Since the remote control uses infrared light to send signals to the projector (Class1 LED), be sure to use the remote control in an area free from obstacles that could block the remote control's output signal to the projector.
- You can use the remote control as a wired remote control, by connecting the REMOTE CONTROL ports of the main unit and remote control via an audio cable (3.5 dia. stereo mini cable with plugs).

Power on/off

**⚠ WARNING** ▶ When the power is on, a strong light is emitted. Do not look into the lens or vents of the projector.

**NOTE** • Turn the power on/off in right order. Please power on the projector before the connected devices. Power off the projector after the connected devices.

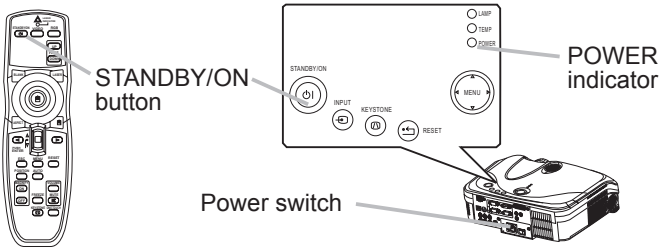

**Turning on the power**

1. Make sure that the power cord is firmly and correctly connected to the projector and outlet.
2. Remove the lens cap, and set the power switch to the ON position.

The power indicator will light to solid orange. Then wait several seconds because buttons may not function for these several seconds.

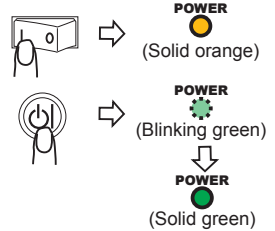

3. Press the STANDBY/ON button on the projector or remote control. The projector lamp will light up and the POWER indicator will begin blinking green. When the power is completely on, the indicator will stop blinking light green.

To display the picture, select an input signal according to the section "Selecting an input signal" (17).

**Turning off the power**

1. Press the STANDBY/ON button on the projector or remote control. The message "Power off?" will appear on the screen for approximately 5 seconds.
2. Press the STANDBY/ON button on the projector or remote control again while the message is visible. The projector lamp will go off, and the POWER indicator will begin blinking orange.

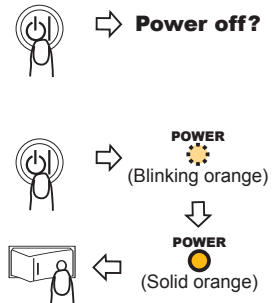

Then the POWER indicator will stop blinking and light to solid orange when the lamp cooling is complete.

3. Make sure that the power indicator lights to solid orange, set the power switch to the OFF position. The POWER indicator will go off. Attach the lens cap.

Operating

### Adjusting the volume

1. Press the VOLUME button on the remote control.
  - A dialog will appear on the screen to aid you in adjusting the volume.
2. Use the cursor buttons ▲/▼ to adjust the volume.
  - To close the dialog and complete the operation, press the VOLUME button again. Even if you don't do anything, the dialog will automatically disappear after a few seconds.

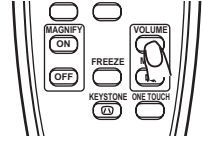

### Temporarily muting the sound

1. Press the MUTE button on the remote control.
  - A dialog will appear on the screen indicating that you have muted the sound.
  - To restore the sound, press the MUTE or VOLUME button.
  - Even if you don't do anything, the dialog will automatically disappear after a few seconds.

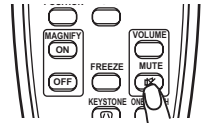

### Selecting an input signal

1. Press the INPUT button on the projector.
  - Each time you press the button, the projector switches its input port as below.

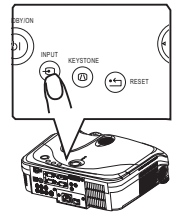

1. Press the RGB button on the remote control to select an input port for RGB signal.
  - Each time you press the button, the projector switches its RGB input port as below.

RGB IN1 → RGB IN2 → DVI-D

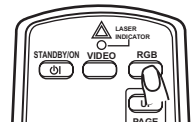

- When the TURN ON is selected to the item AUTO SEARCH of OPTION menu (p.38), the projector checks the current selected port at first. If no input is detected at the port, projector will check other ports in above order.

1. Press the VIDEO button on the remote control to select an input for video signal.
  - Each time you press the button, the projector switches its video input port as below.

COMPONENT VIDEO → S-VIDEO → VIDEO

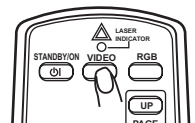

- When the TURN ON is selected to the item AUTO SEARCH of OPTION menu (p.38), the projector checks the current selected video port at first. If no input is detected at the port, projector will begin to check other ports in above order.

## Adjusting screen with ONE-TOUCH

1. Press the ONE TOUCH button on the remote control. This activates the following functions at one time.

- **Signal search:** Projector will cycle through its input ports in order to find any input signal. The search is started from the current port. Then when an input is found, the projector will stop searching and display the image. If no signal is found, the projector will return to the state selected before the operation.

RGB IN1 → RGB IN2 → DVI-D → COMPONENT VIDEO → S-VIDEO → VIDEO  
 ↑

- **Auto adjust:** Projector automatically adjusts the picture position and size in RGB mode, and automatically selects the signal mode in VIDEO input (29).
- **Automatic keystone distortion correction:** Projector automatically corrects vertical keystone distortion due to the (forward/backward) setup angle by itself. This is only performed if ONE TOUCH of the OPTION menu is set to TURN ON (38).

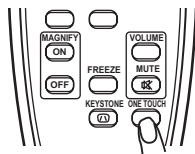

## Selecting an aspect ratio

1. Press the ASPECT button on the remote control. Each time you press the button, the projector switches the mode for aspect ratio in turn.

- **At a RGB/DVI signal**  
 NORMAL → 4:3 → 16:9

↑

- **At a video signal/no signal**  
 4:3 → 16:9 → SMALL

↑

- The NORMAL mode keeps the original aspect ratio of the signal.
- At a HDTV signal of 1125i (1080i) or 750p (720p) of COMPONENT VIDEO input, only 16:9 mode can be selected.
- Performing the automatic adjustment initializes the aspect ratio setting.

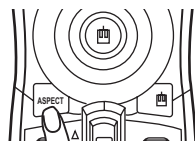

## Adjusting the zoom and focus

1. Use the zoom knob to adjust the screen size.
2. Use the focus ring to focus the picture.

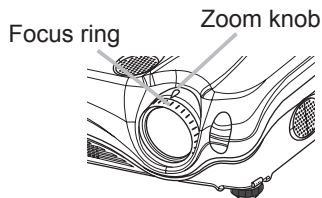

## Using the automatic adjustment feature

1. Press the AUTO button on the remote control.

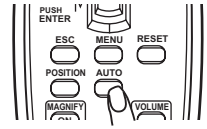

### ○ At a RGB signal

The vertical position, the horizontal position, the clock phase and horizontal size will be automatically adjusted.

Make sure that the application window is set to its maximum size prior to attempting to use this feature. A dark picture may still be incorrectly adjusted. Use a bright picture when adjusting.

### ○ At a video signal

The video format best suited for the respective input signal will be selected automatically.

This function is available only when the AUTO mode is selected to the item VIDEO FORMAT of the INPUT menu (32). For a component video signal, the signal type is identified automatically independently of this function.

- The automatic adjustment operation requires approximately 10 seconds. Also please note that it may not function correctly with some input.

## Adjusting the position

1. Press the POSITION button on the remote control.  
The "POSITION" indication will appear on the screen.
2. Use the cursor buttons ▲/▼/◀/▶ to adjust the picture position.

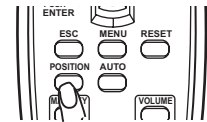

When you want to reset the operation, press the RESET button on the remote control during the operation.

To complete this operation, press the POSITION button again. Even if you don't do anything, the dialog will automatically disappear after a few seconds.

- When this function is performed at a video signal, a certain extra such as a line may appear outside a picture.
- This function does not work when DVI-D input port is selected.

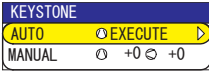

## Correcting the keystone distortions

1. Press the KEYSTONE button on the projector or the remote control. A dialog will appear on the screen to aid you in correcting the distortion.
 
2. Use the cursor buttons ▲/▼ to select AUTO or MANUAL operation, and press the button ► to perform the following.
  - 1) AUTO executes automatic vertical keystone correction. This does not support horizontal keystone correction.
  - 2) MANUAL displays a dialog for horizontal and vertical keystone correction. Select each of them with the button ►, and use the buttons ▲/▼ for adjustment.

To close the dialog and complete this operation, press the KEYSTONE button again. Even if you don't do anything, the dialog will automatically disappear after a few seconds.

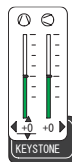

- This function may not work well with some input.
- The adjustable range for correcting will vary among inputs.

## Using the magnify feature

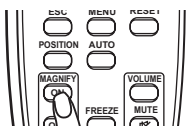
1. Press the ON button of MAGNIFY on the remote control. The "MAGNIFY" indication will appear on the screen (although the indication will disappear in several seconds with no operation), and the projector will enter the MAGNIFY mode.
 
2. Use the cursor buttons ▲/▼ to adjust the zoom level. To move the zoom area, press the POSITION button in the MAGNIFY mode, then use the cursor buttons ▲/▼/◀/▶ to move the area. And to finalize the zoom area, press the POSITION button again.

To exit the MAGNIFY mode and restore the screen to normal, press the OFF button of MAGNIFY on the remote control.

- The projector automatically exits the MAGNIFY mode when the input signal changes, or when an operation of changing the display condition (automatic adjustment, etc.) is executed.
- Although in the MAGNIFY mode, the keystone distortion condition may vary, it will be restored when the projector exit the MAGNIFY mode.

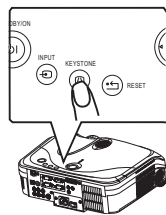

## Freezing the screen

- 1 Press the FREEZE button on the remote control.
  - The “FREEZE” indication will appear on the screen, and the projector will enter the FREEZE mode.

To exit the FREEZE mode and restore the screen to normal, press the FREEZE button again.

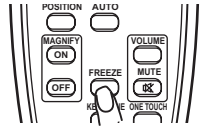

- The projector automatically exits the FREEZE mode when the input signal changes, or when one of the projector's buttons or the remote control buttons of STANDBY/ON, ONE TOUCH, RGB, VIDEO, BLANK, AUTO, ASPECT, VOLUME, MUTE, KEYSTONE, POSITION and MENU is pressed.
- If the projector continues projecting a still image for long time, the LCD panel might possibly be printed. Do not leave the projector in FREEZE mode for too long.

## Temporarily blanking the screen

- 1 Press the BLANK button on the remote control.
  - The blank screen will be displayed instead of the screen of input signal. Please refer to the item BLANK of section SCREEN menu (35).

To remove the blank screen and return to the input signal screen, press the BLANK button again.

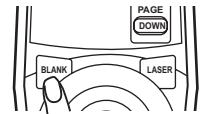

- The projector automatically returns to the input signal screen when the input signal changes, or when one of the projector's buttons or the remote control buttons except the disk pad including the center button for the left click or the right mouse button is pressed.

## Operating the computer screen

**⚠ CAUTION** ▶ Mistaken use of the mouse/keyboard control could damage your equipment.









- While using this function, please connect only with a computer.
- Before connecting, read the manuals of the computer you will connect.

**NOTE** • It may not be possible to control notebook PC, and other computers with built-in pointing device (e.g. track ball), using this remote control. In this case, before connecting go into BIOS (system setup) and select external mouse, and disable the pointing device. In addition, the mouse may not function if the computer does not have the needed utility program. See your computer's hardware manual for details.

- The USB control can be used with Windows 95 OSR 2.1 or higher. It may not be possible to use the remote control, depending on the computer's configurations and mouse drivers.
- The USB control can be used only for the functions listed below. You cannot do things like press two buttons at once (for instance, pressing two buttons at the same time to move the mouse pointer diagonally).
- This function is not available while the lamp is warming up (the POWER indicator flashes green), and while adjusting the volume and display, correcting for trapezoidal distortion, zooming in on the screen, using the BLANK function, or displaying the menu screen.

### USB mouse and keyboard control

1. Connect the projector's USB port to the computer via the mouse cable.

| Available function  | Remote control operation  |
|---|---|
| Move pointer  | Move using  on the disk pad  |
| Left click with mouse   | Press the center  of the disk pad  |
| Right click with mouse  | Press right mouse button   |
| Press keyboard's  keys | Flip the lever switch up  /down  ,<br>press   buttons |
| Press keyboard's ENTER key  | Press ENTER button  |
| Press keyboard's PAGE UP key  | Press PAGE UP button  |
| Press keyboard's PAGE DOWN key  | Press PAGE DOWN button  |
| Press keyboard's ESC key  | Press ESC button  |

## Multifunctional settings

### Using the menu function

This projector has the following menus: PICTURE, IMAGE, VIDEO Qlty., INPUT, SETUP, SCREEN, OPTION, NETWORK and EASY MENU. Each of these menus is operated using the same methods. The basic operations of these menus are as follows.

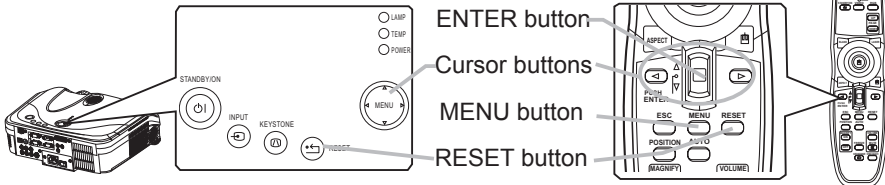

1. Press the MENU button on the remote control or one of the cursor buttons on the projector. The advanced MENU or EASY MENU will appear.

#### At the EASY MENU

2. If you want to change it to the advanced MENU, select the "Go to Advanced Menu".
3. Use the cursor buttons ▲/▼ to select an item to operate.
4. Use the cursor buttons ◀/▶ to operate the item.

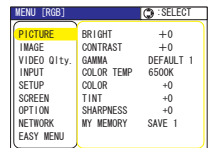

#### At the advanced MENU

2. Use the cursor buttons ▲/▼ to select a menu. If you want to change it to the EASY MENU, select the EASY MENU. Then press the cursor button ▶ on the projector or remote control, or the ENTER button on the remote control to progress. The display of the selected menu will be active.
3. Use the cursor buttons ▲/▼ to select an item to operate. Then press the cursor button ▶ on the projector or remote control, or the ENTER button on the remote control to progress. The operation menu of the selected item will appear.
4. Use the cursor buttons ▲/▼ to operate the item.
  - When you want to reset the operation, press the RESET button on the remote control during the operation. Note that items whose functions are performed simultaneously with operation (ex. LANGUAGE, H PHASE etc.) aren't reset.
  - At the advanced menu, when you want to return to the previous display, press the cursor button ◀ on the projector or remote control, or the ESC button on the remote control.
5. Press the MENU button on the remote control again to close the menu and complete this operation. Even if you don't do anything, the dialog will automatically disappear after about 10 seconds.
  - Some functions cannot be performed when a certain input port is selected, or when a certain input signal is displayed.

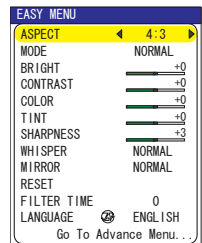

## EASY Menu

With the EASY MENU, items shown in the table below can be performed.

Select an item using the cursor buttons ▲/▼ on the projector or remote control. Then perform it referring to the following table.

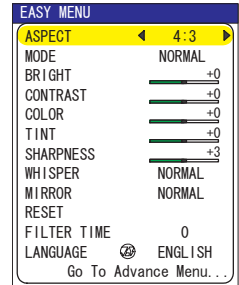

| Item             | Description  |
|------------------|--|
| <b>ASPECT</b>    | Using the buttons ◀/▶ switches the mode for aspect ratio.<br>See the item ASPECT of section IMAGE menu (📖29).  |
| <b>MODE</b>      | Using the buttons ◀/▶ switches the mode of picture type. The modes of picture type are combinations of a mode of GAMMA and a mode of COLOR TEMP. Choose a suitable mode according to the projected source.<br><p style="text-align: center;">NORMAL ↔ CINEMA ↔ DYNAMIC</p> <p style="text-align: center;">↑—————↓</p> <p>NORMAL: (COLOR TEMP = MIDDLE) + (GAMMA = #1 DEFAULT)<br/>           CINEMA: (COLOR TEMP = LOW) + (GAMMA = #2 DEFAULT)<br/>           DYNAMIC: (COLOR TEMP = HIGH) + (GAMMA = #3 DEFAULT)</p> <ul style="list-style-type: none"> <li>• When the combination of GAMMA and COLOR TEMP differs from pre-assigned modes above, the display on the menu for the MODE is “CUSTOM”. Please refer to the items GAMMA (📖26) and COLOR TEMP (📖27) of PICTURE menu.</li> <li>• When this function is performed, a certain extra such as a line may appear.</li> </ul> |
| <b>BRIGHT</b>    | Using the buttons ◀/▶ adjusts the brightness.<br>See the item BRIGHT of section PICTURE menu (📖26).  |
| <b>CONTRAST</b>  | Using the buttons ◀/▶ adjusts the contrast.<br>See the item CONTRAST of section PICTURE menu (📖26).  |
| <b>COLOR</b>     | Using the buttons ◀/▶ adjusts the strength of whole color.<br>See the item COLOR of section PICTURE menu (📖27).  |
| <b>TINT</b>      | Using the buttons ◀/▶ adjusts the tint.<br>See the item TINT of section PICTURE menu (📖27).  |
| <b>SHRPNNESS</b> | Using the buttons ◀/▶ adjusts the sharpness.<br>See the item SHARPNESS of section PICTURE menu (📖27).  |
| <b>WHISPER</b>   | Using the buttons ◀/▶ turns off/on the whisper mode.<br>See the item WHISPER of section SETUP menu (📖34).  |

**EASY Menu (continued)**

| Item                       | Description   |
|----------------------------|---|
| <b>MIRROR</b>              | Using the buttons ◀/▶ switches the mode for mirror status. See the item MIRROR of section SETUP menu (📖34).   |
| <b>RESET</b>               | Performing this item resets all of the items of EASY MENU except FILTER TIME and LANGUAGE. A dialog is displayed to make sure. Selecting RESET using the button ▲ performs reset.   |
| <b>FILTER TIME</b>         | Performing this item resets the filter timer which counts use time of air filter. A dialog is displayed to make sure. Selecting RESET using the button ▲ performs reset. See the item FILTER TIME of section OPTION menu (📖39). |
| <b>LANGUAGE</b>            | Select the LANGUAGE to toggle the menu language. Refer to description of LANGUAGE in the SCREEN menu (📖35).   |
| <b>Go To Advanced Menu</b> | Select the “Go To Advanced Menu” to use the menu of PICTURE, IMAGE, VIDEO Qlty., INPUT, SETUP, SCREEN, OPTION or NETWORK.   |

## PICTURE Menu

With the PICTURE menu, items shown in the table below can be performed.



Select an item using the cursor buttons ▲/▼ on the projector or remote control, and press the cursor button ► on the projector or remote control, or the ENTER button on the remote control to progress. Then perform it referring to the following table.

| MENU [RGB]  |            | SELECT    |
|-------------|------------|-----------|
| PICTURE     | BRIGHT     | +0        |
| IMAGE       | CONTRAST   | +0        |
| VIDEO Qlty. | GAMMA      | DEFAULT 1 |
| INPUT       | COLOR TEMP | 6500K     |
| SETUP       | COLOR      | +0        |
| SCREEN      | TINT       | +0        |
| OPTION      | SHARPNESS  | +0        |
| NETWORK     | MY MEMORY  | SAVE 1    |
| EASY MENU   |            |           |

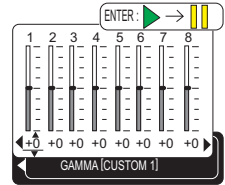
| Item            | Description  |
|-----------------|--|
| <b>BRIGHT</b>   | Using the buttons ▲/▼ adjusts the brightness. : Light ⇄ Dark   |
| <b>CONTRAST</b> | Using the buttons ▲/▼ adjusts the contrast. : Strong ⇄ Weak  |
| <b>GAMMA</b>    | <p>Using the buttons ▲/▼ switches the GAMMA mode.<br/>                     #1 DEFAULT ⇄ #1 CUSTOM ⇄ #2 DEFAULT<br/>                     ⇕ ⇕<br/>                     #3 CUSTOM ⇄ #3 DEFAULT ⇄ #2 CUSTOM</p> <p><b>To adjust #1 CUSTOM, #2 CUSTOM or #3 CUSTOM</b></p> <p>Selecting a mode of CUSTOM and then pressing the button ► or the ENTER button displays a dialog to aid you in adjusting the mode.</p> <p>This function is useful when you want to change the brightness of particular tones.</p> <p>Choose an item using the buttons ◀/▶, and adjust the level using the buttons ▲/▼.</p> <p>You can display a test pattern for checking the effect of your adjustment by pressing the ENTER button. Each time you press the ENTER button, the pattern changes as below.</p> <p>No pattern ⇄ Gray scale of 9 steps ⇄ Ramp ⇄ Gray scale of 15 steps</p> <p>Eight of equalizing bars corresponds to eight of tone level of test pattern except the darkest in the left end. If you want to adjust the 2nd tone from left end on the test pattern, use the equalizing adjustment bar "1". The darkest tone at the left end of the test pattern cannot be controlled with any of equalizing adjustment bar.</p> <ul style="list-style-type: none"> <li>When this function is performed, a certain extra such as a line may appear.</li> </ul> |



**PICTURE Menu (continued)**

| Item                     | Description  |
|--------------------------|--|
| <p><b>COLOR TEMP</b></p> | <p>Using the buttons ▲/▼ switches the mode of color temperature.<br/> HIGH ⇔ MIDDLE ⇔ LOW ⇔ CUSTOM<br/> </p> <p><b>To adjust CUSTOM</b></p> <p>Selecting the CUSTOM and then pressing the button ► or the ENTER button displays a dialog to aid you in adjusting the OFFSET and/or GAIN of CUSTOM mode.</p> <p>OFFSET adjustments change the color intensity on the whole tones of the test pattern.</p> <p>GAIN adjustments mainly affect color intensity on the brighter tones of the test pattern.</p> <p>Choose an item using the buttons ◀/▶, and adjust the level using the buttons ▲/▼.</p> <p>You can display a test pattern for checking the effect of your adjustment by pressing the ENTER button.<br/> Each time you press the ENTER button, the pattern changes as below.</p> <p>No pattern ⇔ Gray scale of 9 steps <br/>  Ramp ⇔ Gray scale of 15 steps</p> <ul style="list-style-type: none"> <li>• When this function is performed, a certain extra such as a line may appear.</li> </ul> |
| <p><b>COLOR</b></p>      | <p>Using the buttons ▲/▼ adjusts the strength of whole color.<br/> Strong ⇔ Weak</p> <ul style="list-style-type: none"> <li>• This item can be selected only at a video signal.</li> </ul>   |
| <p><b>TINT</b></p>       | <p>Using the buttons ▲/▼ adjusts the tint.<br/> Green ⇔ Red</p> <ul style="list-style-type: none"> <li>• This item can be selected only at a video signal.</li> </ul>  |
| <p><b>SHARPNESS</b></p>  | <p>Using the buttons ▲/▼ adjusts the sharpness.<br/> Strong ⇔ Weak</p>   |

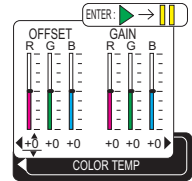

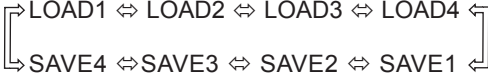

**PICTURE Menu (continued)**

| Item                    | Description  |
|-------------------------|--|
| <p><b>MY MEMORY</b></p> | <p>Selecting a mode of MY MEMORY using the buttons ▲/▼ and then pressing the button ► or the ENTER button performs each function.</p> <div style="text-align: center;">  <p>LOAD1 ↔ LOAD2 ↔ LOAD3 ↔ LOAD4<br/>         SAVE4 ↔ SAVE3 ↔ SAVE2 ↔ SAVE1</p> </div> <p>This projector has 4 numbered memories for adjustment data. Performing the LOAD1, LOAD2, LOAD3 or LOAD4 loads the data on the memory whose number corresponds with the command's number, and adjusts the picture automatically depending on the data. Performing the SAVE1, SAVE2, SAVE3 or SAVE4 puts the current adjustment data on the memory whose number corresponds with the command's number.</p> <ul style="list-style-type: none"> <li>• Current adjustment data of the items in the PICTURE menu is stored.</li> <li>• Although adjustment data under the CUSTOM in the items of GAMMA and COLOR TEMP is not stored, it is memorized that the CUSTOM is selected.</li> </ul> |

## IMAGE Menu

With the IMAGE menu, items shown in the table below can be performed.

Select an item using the cursor buttons ▲/▼ on the projector or remote control, and press the cursor button ► on the projector or remote control, or the ENTER button on the remote control to progress. Then perform it referring to the following table.

| MENU [RGB]   |             | SELECT  |
|--------------|-------------|---------|
| PICTURE      | ASPECT      | 4:3     |
| <b>IMAGE</b> | OVER SCAN   | 95      |
| VIDEO Qlty.  | V POSITION  | 25      |
| INPUT        | H POSITION  | 142     |
| SETUP        | H PHASE     | 16      |
| SCREEN       | H SIZE      | 1344    |
| OPTION       | AUTO ADJUST | EXECUTE |
| NETWORK      |             |         |
| EASY MENU    |             |         |

| Item              | Description  |
|-------------------|--|
| <b>ASPECT</b>     | <p>Using the buttons ▲/▼ switches the mode for aspect ratio.</p> <p><b>At a RGB/DVI signal</b><br/>           4:3 ⇔ 16:9 ⇔ NORMAL<br/>           ↑—————↑</p> <p><b>At a video signal / no signal</b><br/>           4:3 ⇔ 16:9 ⇔ SMALL<br/>           ↑—————↑</p> <ul style="list-style-type: none"> <li>• The NORMAL mode keeps the original aspect ratio of the signal.</li> <li>• At a HDTV signal of 1125i (1080i) or 750p (720p) of COMPONENT VIDEO input, this item can't be selected.</li> <li>• Performing the automatic adjustment initializes the aspect ratio setting.</li> </ul> |
| <b>OVER SCAN</b>  | <p>Using the buttons ▲/▼ adjusts the over-scan ratio.</p> <p>Large (It reduces picture) ⇔ Small (It magnifies picture)</p> <ul style="list-style-type: none"> <li>• This item can be selected only at a video signal.</li> <li>• When this adjustment is too large, certain degradation may appear at the frame area of the picture. In such a case, please adjust small.</li> </ul>   |
| <b>V POSITION</b> | <p>Using the buttons ▲/▼ adjusts the vertical position.</p> <p>Up ⇔ Down</p> <p>This item is not selected when DVI-D input port is selected.</p>   |
| <b>H POSITION</b> | <p>Using the buttons ▲/▼ adjusts the horizontal position.</p> <p>Left ⇔ Right</p> <p>This item is not selected when DVI-D input port is selected.</p>  |
| <b>H PHASE</b>    | <p>Using the buttons ▲/▼ adjusts the horizontal phase to eliminate flicker.</p> <p>Right ⇔ Left</p> <ul style="list-style-type: none"> <li>• This item can be selected only at a RGB signal or a component video signal. Note that this does not work with the input signal of 525i(480i)/625i(576i) from the component video port.</li> </ul>   |

**IMAGE Menu (continued)**



| Item                              | Description   |
|-----------------------------------|---|
| <p><b>H SIZE</b></p>              | <p>Using the buttons ▲/▼ adjusts the horizontal size.<br/>                     Large ↔ Small</p> <ul style="list-style-type: none"> <li>• This item can be selected only at a RGB signal (except DVI-D).</li> <li>• When this adjustment is excessive, the picture may not be displayed correctly. In such a case, please reset the adjustment pressing the RESET button on the remote control during this operation.</li> </ul>  |
| <p><b>AUTO ADJUST EXECUTE</b></p> | <p>Selecting this item performs the automatic adjustment feature.</p> <p><b>At a RGB signal</b><br/>                     The vertical position, the horizontal position, the clock phase and horizontal size will be automatically adjusted.<br/>                     Make sure that the application window is set to its maximum size prior to attempting to use this feature. A dark picture may still be incorrectly adjusted. Use a bright picture when adjusting.</p> <p><b>At a video signal</b><br/>                     The video format best suited for the respective input signal will be selected automatically.<br/>                     This function is available only when the AUTO mode is selected to the item VIDEO FORMAT of INPUT menu. For a component video signal, the signal type is identified automatically independently of this function.</p> <ul style="list-style-type: none"> <li>• The automatic adjustment operation requires approximately 10 seconds. Also please note that it may not function correctly with some input.</li> </ul> |

## VIDEO Qlty. Menu

With the VIDEO Qlty. menu, items shown in the table below can be performed.

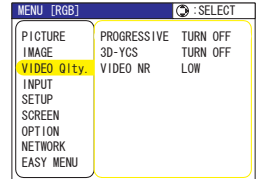
Select an item using the cursor buttons ▲/▼ on the projector or remote control, and press the cursor button ► on the projector or remote control, or the ENTER button on the remote control to progress. Then perform it referring to the following table.





| Item               | Description   |
|--------------------|---|
| <b>PROGRESSIVE</b> | <p>Using the buttons ▲/▼ switches the progressive mode.<br/>           TV ⇄ FILM ⇄ TURN OFF<br/> </p> <ul style="list-style-type: none"> <li>• This function performs only at an interlaced signal of a VIDEO input, a S-VIDEO input or a COMPONENT VIDEO input of 525i (480i) or 625i (576i) signal.</li> <li>• When the TV or FILM is selected, the screen image will be crisper. The FILM mode is adaptable to the 2-3 Pull-Down system to the conversion. But these may cause a certain defect (for example, jagged line) of the picture at a quick moving object. In such a case, please select the TURN OFF, even though the screen image may lose the crisp.</li> </ul> |
| <b>3D-YCS</b>      | <p>Using the buttons ▲/▼ switches the 3D-YCS mode.<br/>           STILL IMAGE ⇄ NORMAL ⇄ TURN OFF</p> <ul style="list-style-type: none"> <li>• This function performs only at a VIDEO input of NTSC 3.58.</li> <li>• NORMAL is the mode for images with a lot of motions like movies, and STILL IMAGE is the mode for images with few motions or completely still ones like slides.</li> <li>• When this function performs, the VIDEO NR function is ineffective.</li> </ul>  |
| <b>VIDEO NR</b>    | <p>Using the buttons ▲/▼ switches the noise reduction mode.<br/>           HIGH ⇄ MIDDLE ⇄ LOW<br/> </p> <ul style="list-style-type: none"> <li>• This function performs only at a VIDEO input or a S-VIDEO input. At a VIDEO input of NTSC 3.58, this function performs only when the TURN OFF is selected under the 3D-YCS.</li> <li>• When the HIGH, the MIDDLE or the LOW is selected, the noise on screen is reduced according to each mode.</li> <li>• When this function is excessive, it may cause a certain degradation of the picture.</li> </ul>  |

## INPUT Menu

With the INPUT menu, items shown in the table below can be performed.

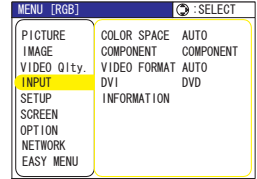
Select an item using the cursor buttons ▲/▼ on the projector or remote control, and press the cursor button ► on the projector or remote control, or the ENTER button on the remote control to progress. Then perform it referring to the following table.



| Item                | Description   |
|---------------------|---|
| <b>COLOR SPACE</b>  | <p>Using the buttons ▲/▼ switches the mode for color space.<br/>                     AUTO ⇄ RGB ⇄ SMPTE240 ⇄ REC709 ⇄ REC601<br/> </p> <ul style="list-style-type: none"> <li>• This item can be selected only at a RGB signal or a component video signal (except signals of 525i(480i)/625i(576i) from the component video port).</li> <li>• The AUTO mode automatically selects the optimum mode.</li> <li>• The AUTO operation may not work well at some signals. In such a case, it might be good to select the SMPTE240 or the REC709.</li> </ul>  |
| <b>COMPONENT</b>    | <p>Using the buttons ▲/▼ switches the function of COMPONENT VIDEO port.<br/>                     COMPONENT ⇄ SCART RGB</p> <p>When the SCART RGB is selected, the COMPONENT VIDEO port function as a port for a SCART RGB signal input. A SCART adapter and SCART cable realize a SCART RGB input to the projector. For details, ask your dealer.</p>   |
| <b>VIDEO FORMAT</b> | <p>Using the buttons ▲/▼ switches the mode for video format.<br/>                     AUTO ⇄ NTSC ⇄ PAL ⇄ SECAM<br/> </p> <ul style="list-style-type: none"> <li>• This item performs only at a video signal from the VIDEO port or the S-VIDEO port. For a component video signal, the signal type is identified automatically independently of this function.</li> <li>• The AUTO mode automatically selects the optimum mode.</li> <li>• The AUTO operation may not work well at some signals. If the picture becomes unstable (ex. an irregular picture, a color lack), please select the mode depending on the input signal.</li> </ul> |
| <b>DVI</b>          | <p>Select a signal source of the DVI-D port using the ▲/▼ buttons.<br/>                     COMPUTER ⇄ DVD</p> <ul style="list-style-type: none"> <li>• If unsuitable setting is chosen, brightest or darkest tones may not be displayed correctly.</li> <li>• When you watch the DVD, always choose the “DVD” in spite of the signal source, the computer or the DVD player.</li> </ul>  |

**INPUT Menu (continued)**

| Item                      | Description   |
|---------------------------|---|
| <p><b>INFORMATION</b></p> | <p>Selecting this item displays a dialog titled “INPUT INFORMATION”. It shows the information about the current input.</p> <div style="display: flex; justify-content: space-around; align-items: flex-start;"> <div style="border: 1px solid black; padding: 5px; width: 30%; text-align: center;"> <p>◀ INPUT-INFORMATION<br/>RGB<br/>1024x768 @60.0<br/>FRAME LOCK</p> </div> <div style="border: 1px solid black; padding: 5px; width: 30%; text-align: center;"> <p>◀ INPUT-INFORMATION<br/>S-VIDEO<br/>SECAM<br/>AUTO</p> </div> <div style="border: 1px solid black; padding: 5px; width: 30%; text-align: center;"> <p>◀ INPUT-INFORMATION<br/>COMPONENT<br/>576i @50<br/>SCART RGB</p> </div> </div> <ul style="list-style-type: none"> <li>• The “FRAME LOCK” message on the dialog means the frame lock function is working. This function automatically works when a RGB signal with vertical frequency of 50 to 60 Hz is input, and it displays a moving picture more smoothly.</li> <li>• The “SCART RGB” message means the COMPONENT VIDEO port is working as a SCART RGB input port. Please refer to the item COMPONENT in this section. ( 32)</li> <li>• This item can't be selected at no signal and sync out.</li> </ul> |

## SETUP Menu

With the SETUP menu, items shown in the table below can be performed.

Select an item using the cursor buttons ▲/▼ on the projector or remote control, and press the cursor button ► on the projector or remote control, or the ENTER button on the remote control to progress. Then perform it referring to the following table.

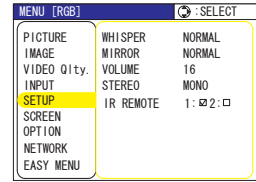

| Item             | Description  |
|------------------|--|
| <b>WHISPER</b>   | Using the buttons ▲/▼ turns off/on the whisper mode.<br>NORMAL ⇔ WHISPER<br>• When the WHISPER is selected, acoustic noise and screen brightness are reduced.  |
| <b>MIRROR</b>    | Using the buttons ▲/▼ switches the mode for mirror status.<br><br>NORMAL ⇔ H:INVERT ⇔ V:INVERT ⇔ H&V:INVERT<br>  |
| <b>VOLUME</b>    | Using the buttons ▲/▼ adjusts the volume.<br>High ⇔ Low  |
| <b>STEREO</b>    | Using the buttons ▲/▼ selects the internal speaker output mode.<br>MONO ⇔ STEREO   |
| <b>IR REMOTE</b> | Select a remote sensor using the ▲/▼ button (1), then switch it using the ► or the ENTER button (2).<br>(1) 1 : FRONT ⇔ 2 : TOP    (2) <input type="checkbox"/> (Off) ⇔ <input checked="" type="checkbox"/> (On)<br>• A sensor cannot be turned off when the other is off. |

## SCREEN Menu

With the SCREEN menu, items shown in the table below can be performed.

Select an item using the cursor buttons ▲/▼ on the projector or remote control, and press the cursor button ► on the projector or remote control, or the ENTER button on the remote control to progress. Then perform it referring to the following table.

| MENU [RGB]    |               | SELECT   |
|---------------|---------------|----------|
| PICTURE       | LANGUAGE      | ENGLISH  |
| IMAGE         | MENU POSITION |          |
| VIDEO Q.ty.   | OSD BRIGHT    | 5        |
| INPUT         | BLANK         | BLACK    |
| SETUP         | START UP      | ORIGINAL |
| <b>SCREEN</b> | MyScreen      |          |
| OPTION        | MyScreen Lock | TURN OFF |
| NETWORK       | MESSAGE       | TURN ON  |
| EASY MENU     |               |          |

| Item                 | Description   |
|----------------------|---|
| <b>LANGUAGE</b>      | <p>Using the buttons ▲/▼ switches the OSD (On Screen Display) language.</p> <p>ENGLISH ⇄ FRANÇAIS ⇄ DEUTSCH ⇄ ESPAÑOL ⇄ ITALIANO</p> <p>NORSK ⇄ NEDERLANDS ⇄ PORTUGUÊS ⇄ 日本語</p> <p>简体中文 ⇄ 繁體中文 ⇄ 한글 ⇄ SVENSKA ⇄ РУССКИЙ</p> <p>SUOMI ⇄ POLSKI ⇄ TÜRKÇE</p>   |
| <b>MENU POSITION</b> | <p>Using the buttons ◀/▶/▲/▼ adjusts the menu position.</p> <p>To quit the operation, press the MENU button on the remote control or keep no operation for 10 seconds.</p>  |
| <b>OSD BRIGHT</b>    | <p>Using the buttons ▲/▼ switches the brightness level of the OSD (On Screen Display).</p> <p>BRIGHT ⇄ DARK</p>   |
| <b>BLANK</b>         | <p>Using the buttons ▲/▼ switches the mode for the blank screen.</p> <p>The blank screen is the screen for the temporarily blanking feature (21). It is displayed by pressing the BLANK button on the remote control.</p> <p>MyScreen ⇄ ORIGINAL ⇄ BLUE ⇄ WHITE ⇄ BLACK</p> <p>MyScreen is the screen you can register a desired screen. ORIGINAL screen is the existing standard screen. BLUE, WHITE and BLACK are non-patterned (plain) screens in each color.</p> <ul style="list-style-type: none"> <li>To avoid remaining as an afterimage, the MyScreen and the ORIGINAL screens will change to the BLACK screen after several minutes.</li> <li>For the MyScreen, please refer to the item MyScreen (36).</li> </ul> |



**SCREEN Menu (continued)**

| Item                         | Description  |
|------------------------------|--|
| <p><b>START UP</b></p>       | <p>Using the buttons ▲/▼ switches the mode for the start up screen. The start up screen is the screen displayed when no signal or an unsuitable signal is detected.</p> <p>MyScreen ⇄ ORIGINAL ⇄ TURN OFF</p>  <p>MyScreen is the screen you can register a desired screen. ORIGINAL screen is the existing standard screen. When the TURN OFF is selected, the BLACK screen is used.</p> <ul style="list-style-type: none"> <li>• To avoid remaining as an afterimage, the MyScreen and the ORIGINAL screens will change to the BLANK screen after several minutes. If also the BLANK screen is the MyScreen or ORIGINAL, it will change to the BLACK screen.</li> <li>• For the MyScreen, please refer to the item MyScreen below. About the BLANK screen, please refer to the item BLANK (📖35).</li> </ul>   |
| <p><b>My Screen</b></p>      | <p>This item functions for capturing the MyScreen of the blank screen and the start up screen. Please execute displaying the input including the picture you want to capture.</p> <ol style="list-style-type: none"> <li>1. Selecting this item displays a dialog titled “MyScreen”. It will ask you if you start capturing the picture from the current screen. Please wait for the target picture to be displayed, and press the ENTER button on the remote control when the picture is display. The picture will freeze and the frame for capturing appears. To stop performing, press the RESET or ESC button on the remote control.</li> <li>2. Using the buttons ◀/▶/▲/▼ adjust the frame position. Please move the frame to the position of the picture which you want to use. To start registration, press the ENTER button on the remote control. To restore the screen and return to the previous dialog, press the RESET or ESC button on the remote control.</li> </ol> <p>Registration takes several minutes. When the registration is completed, the registered screen and the message “MyScreen registration is finished.” are displayed for several seconds. If the registration failed, the message “A capturing error has occurred. Please try again.” is displayed.</p> |
| <p><b>My Screen Lock</b></p> | <p>Using the buttons ▲/▼ turns on/off the MyScreen lock function.</p> <p>TURN ON ⇄ TURN OFF</p> <p>When the TURN ON is selected, the item MyScreen cannot be performed. Use this function for protecting the current MyScreen.</p>   |

**SCREEN Menu (continued)**

| Item           | Description   |
|----------------|---|
| <b>MESSAGE</b> | <p>Using the buttons ▲/▼ turns on/off the message function.<br/>           TURN ON ⇔ TURN OFF</p> <p>When the TURN ON is selected, the following message function works.</p> <p>“AUTO IN PROGRESS” while automatically adjusting<br/>           ”NO INPUT IS DETECTED”<br/>           ”SYNC IS OUT OF RANGE”<br/>           "Searching...." while searching for the input<br/>           ”Detecting....” while an input signal is detected<br/>           The indication of the input signal by changing<br/>           The indication of the aspect ration by changing</p> |

## OPTION Menu

With the OPTION menu, items shown in the table below can be performed.

Select an item using the cursor buttons ▲/▼ on the projector or remote control, and press the cursor button ► on the projector or remote control, or the ENTER button on the remote control to progress, except for the items LAMP TIME and FILTER TIME. Then perform it referring to the following table.

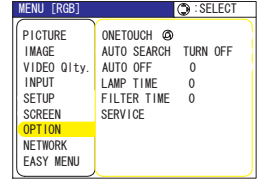

| Item                      | Description  |
|---------------------------|--|
| <p><b>ONE TOUCH</b></p>   | <p>Using the buttons ▲/▼ turns on/off the automatic keystone correction function.</p> <p>TURN ON ⇔ TURN OFF</p> <p>You can automatically correct vertical keystone distortion corresponding to the angle (forward/backward tilt) at which the unit is set up. This function works with ONE TOUCH operation.</p> <ul style="list-style-type: none"> <li>• If the projection screen is inclined, or if the projector is angled downwards, it may not be possible to make the correct adjustment when V: INVERT or H&amp;V: INVERT is selected under the MIRROR item of the SETUP menu.</li> <li>• When the zoom adjustment is set to the TELE side, automatic correction may be excessive. The automatic correction function should be used with zoom set to WIDE whenever possible.</li> </ul>  |
| <p><b>AUTO SEARCH</b></p> | <p>Using the buttons ▲/▼ turns on/off the automatic signal search function.</p> <p>TURN ON ⇔ TURN OFF</p> <p>This function works with INPUT, RGB, and VIDEO buttons. When the TURN ON is selected, detecting no signal automatically cycles through input ports in order of following. The search is started from the current port. Then when an input is found, the projector will stop searching and display the image.</p> <p>RGB IN1 ⇒ RGB IN2 ⇒ DVI-D ⇒ COMPONENT VIDEO ⇒ S-VIDEO ⇒ VIDEO</p> <p>↑</p>  |
| <p><b>AUTO OFF</b></p>    | <p>Using the buttons ▲/▼ adjusts the time to count down to automatically turn the projector off.</p> <p>Long (max. 99 minutes) ⇔ Short (min. 0 minute = DISABLE)</p> <div style="display: flex; justify-content: space-around; align-items: center;"> <div style="border: 1px solid black; padding: 5px; text-align: center;"> <p>← AUTO OFF</p> <p>ENABLE</p> <p>▲</p> <p>1</p> <p>▼</p> </div> <div style="border: 1px solid black; padding: 5px; text-align: center;"> <p>← AUTO OFF</p> <p>DISABLE</p> <p>▲</p> <p>0</p> <p>▼</p> </div> </div> <p>When the time is set to 0, the projector is not turned off automatically. When the time is set to 1 to 99, and when the passed time with a no-signal or an unsuitable signal reaches at the set time, the projector lamp will go off and the power indicator begins blinking. Please refer to the section “Turning off the power” (16).</p> |

## OPTION Menu (continued)

| Item               | Description  |
|--------------------|--|
| <b>LAMP TIME</b>   | <p>The lamp time is the time counted after the last resetting. It is shown in the OPTION menu as the use time of the lamp. Pressing the RESET button on the remote control or the button ► of the projector for about 3 seconds displays a dialog. To reset the lamp time, select the RESET using the button ▲.</p> <p>RESET ⇄ CANCEL</p> <ul style="list-style-type: none"> <li>• Please reset the lamp time only when you have replaced the lamp, for correct messages about the lamp.</li> <li>• About the lamp replacement, see the section "Lamp" (44, 45).</li> </ul>  |
| <b>FILTER TIME</b> | <p>The filter time is the time counted after the last resetting. It is shown in the OPTION menu as the use time of the air filter. Pressing the RESET button on the remote control or the button ► of the projector for about 3 seconds displays a dialog. To reset the filter time, select the RESET using the button ▲.</p> <p>RESET ⇄ CANCEL</p> <ul style="list-style-type: none"> <li>• Please reset the filter time only when you have cleaned or replaced the air filter, for correct messages about the air filter.</li> <li>• About the caring the air filter, see the section "Air filter" (46).</li> </ul>  |
| <b>SERVICE</b>     | <p>Selecting this item displays the SERVICE menu. Select an item using the buttons ▲/▼, and press the button ► or the ENTER button on the remote control to progress.</p> <p>FAN SPEED ⇄ AUTO ADJUST ⇄ GHOST ⇄ FACTORY RESET<br/> </p> <p><b>FAN SPEED</b><br/>Using the buttons ▲/▼ switches the rotation speed of the cooling fans. The HIGH is the mode for use at highlands etc. Note that the projector is noisier when the HIGH is selected.</p> <p>HIGH ⇄ NORMAL</p> <p><b>AUTO ADJUST</b><br/>Using the buttons ▲/▼ enable/disable the automatic adjustment.</p> <p>ENABLE ⇄ DISABLE</p> <p><b>GHOST</b><br/>1. Select a color element of ghost using the buttons ◀/▶.<br/>2. Adjust the selected element using the buttons ▲/▼ to disappear ghost.</p> <p><b>FACTORY RESET</b><br/>Selecting RESET using the button ▲ performs this function. By this function, all the items in all of menu will collectively return to the initial setting. Note that the items LAMP TIME, FILTER TIME and LANGUAGE are not reset.</p> <p>RESET ⇄ CANCEL</p> |

## NETWORK Menu

With the NETWORK menu, items shown in the table below can be performed.

Select an item using the cursor buttons ▲/▼ on the projector or remote control, and press the cursor button ► on the projector or remote control, or the ENTER button on the remote control to progress. Then perform it referring to the following table.

Make your Network settings by manual operation as following the dialog box.

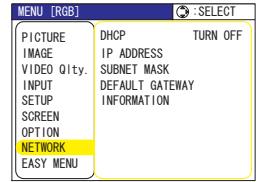

| Item                   | Description   |
|------------------------|---|
| <b>DHCP</b>            | Using the buttons ▲/▼ turns on/off the DHCP function.<br>TURN ON ⇔ TURN OFF<br>If your network doesn't support the DHCP function, select the TURN OFF.                    |
| <b>IP ADDRESS</b>      | Enter the IP address of the projector using the ◀/▶/▲/▼ buttons.<br>This menu is available only when the item of the DHCP is set to TURN OFF.                             |
| <b>SUBNET MASK</b>     | Enter the SUBNET MASK of your NETWORK using the ◀/▶/▲/▼ buttons.<br>This menu is available only when the item of the DHCP is set to TURN OFF.                             |
| <b>DEFAULT GATEWAY</b> | Enter the DEFAULT GATEWAY. This is the address of the device as gateway to an outer network.<br>This menu is available only when the item of the DHCP is set to TURN OFF. |
| <b>INFORMATION</b>     | Selecting this item shows the information about the current network setting of the projector.   |

## NETWORK Menu (continued)

This projector provides the NETWORK function. When you start to use this function, please consult your dealer for further information.

To start, connect the LAN port to a gateway device via a CAT-5 cable, then set up the projector according to the Network environment in which you use it.

### When your network enables the DHCP function

You can set automatically, if you set the DHCP function to TURN ON using the NETWORK menu. Please refer to the section NETWORK menu (40).

### When your network doesn't support the DHCP function or when you use a fixed address even if your network can support the DHCP function

Please set the IP address, the subnet mask, the default gateway and the DHCP using the NETWORK menu. At first, set the DHCP function to TURN OFF.

It is also possible to configure the projector's network settings using a Web browser (Internet Explorer 5.0 or higher; Netscape 6.2 or higher) on a computer connected to the network. When using a Web browser to configure the projector's network settings, password access is required. However, since a password is not configured when the product is shipped from the factory, if a password has not been configured, then you can simply click on Login without entering a password to access the Projector Network Configuration dialog.

To configure the settings using a Web browser, proceed as follows:

#### ex. Case of IP Address = 192.168.1.10

1. Enter http://192.168.1.10 into the Web browser's address field.
2. Once Screen 1 is displayed (as shown on the right), enter the password and then click on "Login".
3. Once Screen 2 is displayed (as shown on the right), select the desired item by clicking the corresponding ENTER button.

Screen 1

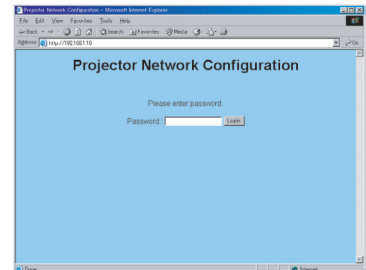

Screen 2

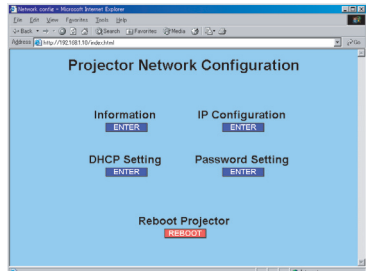

#### Information

Allows you to confirm the current network settings. (Screen 3)

#### IP Configuration

Allows you to configure IP address, subnet mask and default gateway if DHCP is disabled. (Screen 4)

#### DHCP Setting

Allows you to enable or disable DHCP. (Screen 5)

#### Password Setting

Allows you to change the login password. (Screen 6)

### NETWORK Menu (continued)

#### Information

- 1) Allows you to confirm the current network settings of the projector.
- 2) Click on "return to top page" to return to Screen 2.

#### Screen 3

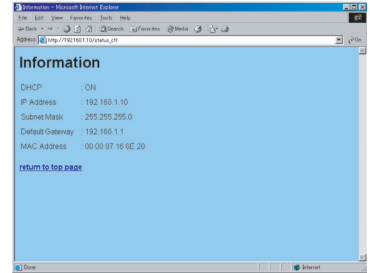

#### IP Configuration

Allows you to configure the IP address, subnet mask and default gateway if DHCP is disable.

- 1) Enter the IP address.
- 2) Enter the subnet mask.
- 3) Enter the default gateway.
- 4) Click on "Write".
- 5) Click on "return to top page" to return to Screen 2.

#### Screen 4

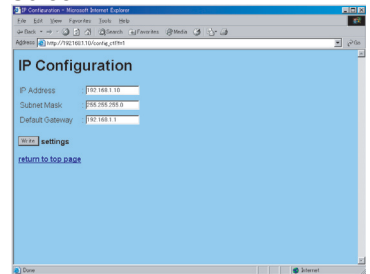

#### DHCP Setting

- 1) Check the "DHCP" box to enable DHCP or uncheck the "DHCP" box to disable DHCP.
- 2) Click on "Write".
- 3) Click on "return to top page" to return to Screen 2.

#### Screen 5

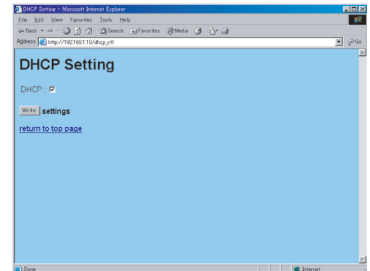

#### Password Setting

- 1) Enter the current password.
- 2) Enter the new password.
- 3) Enter the new password again.
- 4) Click on "OK".
- 5) Click on "return to top page" to return to Screen 2.

#### Screen 6

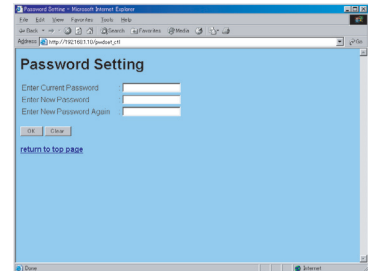

• The password is case sensitive and can be up to 16 single-byte alphanumeric characters in length.

**NETWORK Menu (continued)**

4. If you modified the IP configuration or the DHCP setting, click on "Reboot" in Screen 2 to have the settings take effect.
5. Close the Web browser to end the configuration session.

**NOTE** • If the Projector Network Configuration dialog is accessed by more than one computer at the same time, the last computer to login retains the authority to modify the settings. If you wish to make changes using a computer that logged on earlier, you will need to login again to regain authority.

- Except for the login screen, all of the screens will timeout after 10 minutes of no operation. Should this occur, you will need to login again to modify the settings.
- The 10-minute timeout remains in effect even if you close the Web browser and end the configuration session. Therefore, if you try to reestablish a session from the same computer before the 10-minute timeout occurs, the login screen will not reappear. However, if you reboot or if you login from another PC, the 10-minute timeout will no longer be in effect.



## Maintenance

## Lamp

**WARNING**

HIGH VOLTAGE



HIGH TEMPERATURE



HIGH PRESSURE

► The projector uses a high-pressure mercury glass lamp. The lamp can break with a loud bang, or burn out, if jolted or scratched, handled while hot, or worn over time. Note that each lamp has a different lifetime, and some may burst or burn out soon after you start using them. In addition, when the bulb bursts, it is possible for shards of glass to fly into the lamp housing, and for gas containing mercury to escape from the projector's vent holes.

► **About disposal of a lamp** • This product contains a mercury lamp; do not put in trash. Dispose of in accord with environmental laws. For lamp recycling, go to [www.lamprecycle.org](http://www.lamprecycle.org). (in the US) For product disposal, contact your local government agency or [www.eiae.org](http://www.eiae.org) (in the US) or [www.epsc.ca](http://www.epsc.ca) (in Canada). For more information, call your dealer.



Disconnect the plug from the power outlet

- If the lamp should break (it will make a loud bang when it does), unplug the power cord from the outlet, and make sure to request a replacement lamp from your local dealer. Note that shards of glass could damage the projector's internals, or cause injury during handling, so please do not try to clean the projector or replace the lamp yourself.
- If the lamp should break (it will make a loud bang when it does), ventilate the room well, and make sure not to breathe the gas that comes out of the projector vents, or get it in your eyes or mouth.
- Before replacing the lamp, turn the projector off and unplug the power cord, then wait at least 45 minutes for the lamp to cool sufficiently. Handling the lamp while hot can cause burns, as well as damaging the lamp.



- Never unscrew except the appointed (marked by an arrow) screws.
- Do not open the lamp cover while the projector is suspended from above. This is dangerous, since if the lamp's bulb has broken, the shards will fall out when the cover is opened. In addition, working in high places is dangerous, so ask your local dealer to have the lamp replaced even if the bulb is not broken.
- Do not use the projector with the lamp cover removed. At the lamp replacing, make sure that the screws are screwed in firmly. Loose screws could result in damage or injury.



- Use only the lamp of the specified type.
- If the lamp breaks soon after the first time it is used, it is possible that there are electrical problems elsewhere besides the lamp. If this happens, contact your local dealer or a service representative.
- Handle with care: jolting or scratching could cause the lamp bulb to burst during use.
- If the indicators or a message prompts you to replace the lamp (see the section "Related Messages" and "Regarding the indicator Lamps"), replace the lamp as soon as possible. Using the lamp for long periods of time, or past the replacement date, could cause it to burst. Do not use old (used) lamps; this is a cause of breakage.

**Lamp (continued)**

When the indicators or a message prompts you to replace the lamp, replace the lamp as soon as possible.

1. Turn the projector off, and unplug the power cord. Allow the lamp to cool for at least 45 minutes.
2. To prepare a new lamp, contact your dealer and tell the lamp type number = **456-8915**. If the projector is mounted on the ceiling, or if the lamp has broken, also ask the dealer to replace the lamp.

**In the case of replacement by yourself,**

3. After making sure that the projector has cooled adequately, slowly turn over the projector, so that the bottom is facing up.
4. Please unhook the claws of the lamp cover using a minus screwdriver or similar, and remove the lamp cover.
5. Loosen the 2 screws (marked by arrow) of the lamp, and slowly pick up the lamp by the handles.
6. Insert the new lamp, and retighten firmly two screws that are loosened in the previous process to lock it in place.
7. Interlocking the 2 tabs of the lamp cover to the projector, position the lamp cover on the projector. Then push the center point of two claws to fix the lamp cover.
8. Slowly turn the projector so that the top is facing up.
9. Turn the projector on, and reset the lamp time using the LAMP TIME function of OPTION menu (📖 39).

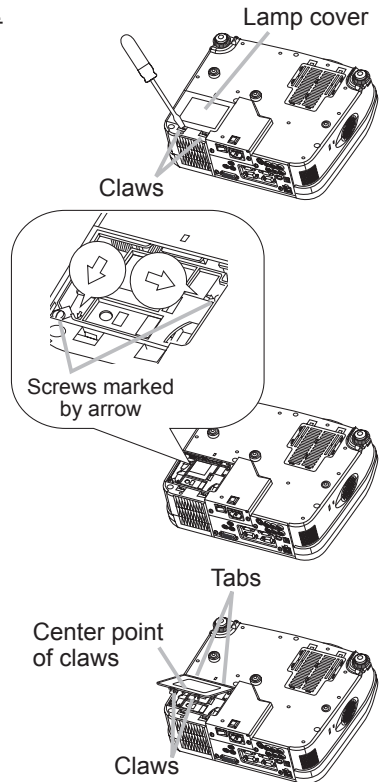

**NOTE** • When the lamp has been replaced after the message of "THE POWER WILL TURN OFF AFTER 0hr." is displayed, complete the following operation within 10 minutes of switching power on.

- Incorrectly resetting of the lamp timer (resetting without replacement, or neglect of resetting after replacement) will result in incorrect message functions.

## Air filter

**⚠ WARNING** ▶ Before caring, make sure the power switch is off and the power cable is not plugged in, then allow the projector to cool sufficiently. The care in a high temperature state of the projector could cause a burn and/or malfunction to the projector.

▶ Use only the air filter of the specified type. Do not use the projector with the air filter and filter cover removed.

▶ Avoid wetting the projector or inserting liquids in the projector. It could result in a fire, an electric shock, and/or malfunction to the projector.

**⚠ CAUTION** ▶ Please replace the air filter when it is damaged or too soiled, and also when you replace the lamp.

When the indicators or a message prompts you to clean the air filter, clean the air filter as soon as possible. If the air filter becomes clogged by dust or the like, internal temperatures rise and the power may be automatically turned off for malfunction prevention.

1. Turn the projector off, and unplug the power cord.
  1. Allow the projector to cool for at least 45 minutes. And prepare a vacuum cleaner.
2. After making sure that the projector is cool adequately, slowly turn the projector so that the lens-side is facing up. Please be careful for a projector not to fall. While the projector is placed lens-side up, hold the projector.
3. Unhooking the filter cover's claws, pull the filter cover in the direction of the arrow to remove it.
4. Holding the air filter's knob, pull the air filter off.
5. Apply a vacuum cleaner to the vent of the projector for the air filter. And then slowly turn the projector bottom up.
6. Apply a vacuum cleaner to the air filter and filter cover. Please replace the air filter when it is damaged or too soiled.

To prepare a new air filter, contact your dealer and tell the air filter type number = **NJ20642**.

An air filter of specified type will come even with the replacement lamp for this projector.

7. Position the cleaned air filter or a new air filter into place, and push the points of "PUSH" word with claws to fix the air filter.
8. Replace the filter cover and snap it back into place.
9. Slowly turn the projector so that the top is facing up.
10. Turn the projector on, and reset the filter time using the FILTER TIME function of OPTION menu (📖39).

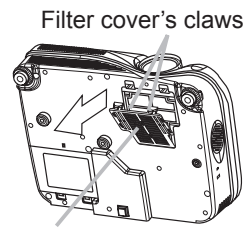

Filter cover's claws  
Filter cover

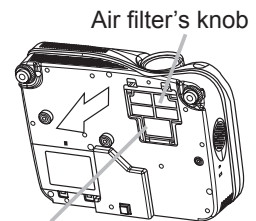

Air filter's knob  
Air filter

**NOTE** • Incorrectly resetting of the filter timer (resetting without replacement, or neglect of resetting after replacement) will result in incorrect message functions.

## Other care

**⚠ WARNING** ▶ Before caring, make sure the power switch is off and the power cable is not plugged in, and then allow the projector to cool sufficiently. The care in a high temperature state of the projector could cause a burn and/or malfunction to the projector.

▶ Never try to care for the inside of the projector personally. Doing is so dangerous.

▶ Avoid wetting the projector or inserting liquids in the projector. It could result in a fire, an electric shock, and/or malfunction to the projector.

- Don't put a container containing water, cleaner or chemicals near the projector.
- Don't use aerosols or sprays.

**⚠ CAUTION** ▶ Please take right care of the projector according to the following. Incorrect care could cause not only an injury but adverse influence such as discoloration, peeling paint, etc.

▶ Do not use cleaner or chemicals other than those listed below.

▶ Do not polish or wipe with hard objects.

### Inside of the projector

In order to ensure the safe use of your projector, please have it cleaned and inspected by your dealer about once every 2 years.

### Caring for the lens

If the lens is flawed, soiled or fogged, it could cause deterioration of display quality. Please take care of the lens, being cautious of the handling.

1. Turn the projector off, and unplug the power cord. Allow the projector to cool sufficiently.
2. After making sure that the projector is cool adequately, lightly wipe the lens with a commercially available lens-cleaning wipe. Do not touch the lens directly with your hand.

### Caring for the cabinet and remote control

Incorrect care could have adverse influence such as discoloration, peeling paint, etc.

1. Turn the projector off, and unplug the power cord. Allow the projector to cool sufficiently.
2. After making sure that the projector is cool adequately, lightly wipe with gauze or a soft cloth.

If soiling is severe, dip soft cloth in water or a neutral cleaner dilute in water, and wipe lightly after wringing well. Then, wipe lightly with a soft, dry cloth.

## Troubleshooting

### Related messages

When the unit's power is on, messages such as those shown below may be displayed. When any such message is displayed on the screen, please respond as described below. If the same message is displayed after the treatment, or if a message other than the following appears, please contact your dealer or service company.

Although these messages will be automatically disappeared around several minutes, it will be reappeared every time the power is turned on.

| Message  | Description  |
|--|--|
| <p>☼ <b>CHANGE THE LAMP</b></p> <p><b>AFTER REPLACING LAMP, RESET THE LAMP TIMER.</b></p>  | <p><b>The time the lamp timer has counted is approaching 2000 hours.</b><br/>Preparation of a new lamp, and an early lamp change is recommended. After you have change the lamp, please be sure to reset the lamp timer(📖39).</p>  |
| <p>☼ <b>CHANGE THE LAMP</b></p> <p><b>AFTER REPLACING LAMP, RESET THE LAMP TIMER.</b></p> <p><b>THE POWER WILL TURN OFF AFTER ** hr.</b></p> | <p><b>The time the lamp timer has counted is approaching 2000 hours, so a lamp change within ** hours is recommended.</b><br/>When lamp usage reaches 2000 hours, the power will automatically be turned off. Please change the lamp by referring to the section “Lamp”. After you have changed the lamp, please be sure to reset the lamp timer(📖39).</p> |
| <p>☼ <b>CHANGE THE LAMP</b></p> <p><b>AFTER REPLACING LAMP, RESET THE LAMP TIMER.</b></p> <p><b>THE POWER WILL TURN OFF AFTER 0 hr.</b></p>  | <p><b>As the time the lamp timer has counted has reached 2000 hours, the power will soon be automatically turned off.</b><br/>Please immediately turn the power off, and change the lamp by referring to the section “Lamp”. After changing the lamp, please be sure to reset the lamp timer(📖39).</p>   |
| <p><b>NO INPUT IS DETECTED ON ***</b></p>  | <p><b>There is no input signal.</b><br/>Please confirm the signal input connection, and the status of the signal source.</p>   |
| <p><b>SYNC IS OUT OF RANGE ON *** [fH] *****kHz [fV] *****Hz</b></p>   | <p><b>The horizontal or vertical wavelength of the inputted signal is outside of the response parameters of this unit.</b><br/>Please confirm the specs for this unit or the signal source specs.</p>  |

**Related messages (continued)**

| Message   | Description  |
|---|--|
| <p><b>CHECK THE AIR FLOW</b></p>  | <p><b>The internal portion temperature is rising.</b><br/>                     Please turn the power OFF, and allow the unit to cool down at least 20 minutes. After having confirmed the following items, please turn the power ON again.</p> <ul style="list-style-type: none"> <li>• Is there blockage of the air passage aperture?</li> <li>• Is the air filter dirty?</li> <li>• Does the peripheral temperature exceed 35°C?</li> </ul> <p>If the same indication is displayed after the treatment, please set the HIGH at the FAN SPEED of the item SERVICE of the OPTION menu.</p> |
| <p><b>CLEAN THE AIR FILTER<br/>                     POWER OFF FIRST,<br/>                     THEN CLEAN THE AIR<br/>                     FILTER.<br/>                     AFTER CLEANING THE AIR<br/>                     FILTER,<br/>                     RESET THE FILTER TIMER.</b></p> | <p><b>A note of precaution when cleaning the air filter.</b><br/>                     Please immediately turn the power OFF, and clean or change the air filter by referring to the “Air Filter” section of this manual. After you have cleaned or changed the air filter, please be sure to reset the filter timer(  39).</p>  |

**NOTE** • A lamp has a finite product life. Lamps are characterized by the fact that, after long hours of usage, a lamp will no longer light up, or the lamp will break or burst, etc. This projector is equipped with an automatic shut-down function, such that the power will automatically be turned off when lamp usage time has reached 2000 hours. Please be aware, however, that among lamp types, there are major differences in product lifetimes; a lamp may thus fail to light even prior to the functioning of the automatic shut-down function of this projector.

## Regarding the indicator lamps

Lighting and flashing of the POWER indicator, the LAMP indicator, and the TEMP indicator have the meanings as described in the table below. Please respond in accordance with the instructions within the table. If the same indication is displayed after the treatment, or if an indication other than the following is displayed, please contact your dealer or service company.

| POWER indicator   | LAMP indicator                   | TEMP indicator       | Description  |
|---|----------------------------------|----------------------|--|
| Lighting<br>In <b>Orange</b>  | Turned<br><b>off</b>             | Turned<br><b>off</b> | <b>The projector is in a standby state.</b><br>Please refer to the section "Power On/Off".   |
| <i>Blinking</i><br>In <b>Green</b>                                  | Turned<br><b>off</b>             | Turned<br><b>off</b> | <b>The projector is warming up.</b><br>Please wait.  |
| Lighting<br>In <b>Green</b>   | Turned<br><b>off</b>             | Turned<br><b>off</b> | <b>The projector is in an on state.</b><br>Ordinary operations may be performed.   |
| <i>Blinking</i><br>In <b>Orange</b>                                 | Turned<br><b>off</b>             | Turned<br><b>off</b> | <b>The projector is cooling down.</b><br>Please wait.  |
| <i>Blinking</i><br>In <b>Red</b>                                    | (discre-<br>tionary)             | (discre-<br>tionary) | <b>The projector is cooling down. A certain error has been detected.</b><br>Please wait until the POWER indicator finishes blink, and then perform the proper response measure using the item descriptions below as reference.   |
| <i>Blinking</i><br>In <b>Red</b><br>or<br>Lighting<br>In <b>Red</b> | Lighting<br>In <b>Red</b>        | Turned<br><b>off</b> | <b>The lamp does not light, and there is a possibility that interior portion has become heated.</b><br>Please turn the power off, and allow the unit to cool down at least 20 minutes. After the projector has sufficiently cooled down, please make confirmation of the following items, and then turn the power on again. <ul style="list-style-type: none"> <li>• Is there blockage of the air passage aperture?</li> <li>• Is the air filter dirty?</li> <li>• Does the peripheral temperature exceed 35°C?</li> </ul> If the same indication is displayed after the treatment, please change the lamp by referring to the section "Lamp". |
| <i>Blinking</i><br>In <b>Red</b><br>or<br>Lighting<br>In <b>Red</b> | <i>Blinking</i><br>In <b>Red</b> | Turned<br><b>off</b> | <b>The lamp cover has not been properly fixed (attached).</b><br>Please turn the power off, and allow the unit to cool down at least 45 minutes. After the projector has sufficiently cooled down, please make confirmation of the attachment state of the lamp cover. After performing any needed maintenance, turn the power on again. If the same indication is displayed after the treatment, please contact your dealer or service company.   |

Regarding the indicator lamps (continued)

| POWER indicator                                  | LAMP indicator                      | TEMP indicator         | Description  |
|--|-------------------------------------|------------------------|--|
| Blinking In <b>Red</b> or Lighting In <b>Red</b> | Turned off                          | Blinking In <b>Red</b> | <b>The cooling fan is not operating.</b><br>Please turn the power off, and allow the unit to cool down at least 20 minutes. After the projector has sufficiently cooled down, please make confirmation that no foreign matter has become caught in the fan, etc., and then turn the power on again.<br>If the same indication is displayed after the treatment, please contact your dealer or service company.   |
| Blinking In <b>Red</b> or Lighting In <b>Red</b> | Turned off                          | Lighting In <b>Red</b> | <b>There is a possibility that the interior portion has become heated.</b><br>Please turn the power off, and allow the unit to cool down at least 20 minutes. After the projector has sufficiently cooled down, please make confirmation of the following items, and then turn the power on again.<br><ul style="list-style-type: none"> <li>• Is there blockage of the air passage aperture?</li> <li>• Is the air filter dirty?</li> <li>• Does the peripheral temperature exceed 35°C?</li> </ul> If the same indication is displayed after the treatment, please set the HIGH at the FAN SPEED of the item SERVICE of the OPTION menu. |
| Lighting In <b>Green</b>                         | Alternative blinking in <b>Red</b>  |                        | <b>There is a possibility that the interior portion has become overcooled.</b><br>Please use the unit within the usage temperature parameters (5°C to 35°C). After the treatment, resent the power to ON.  |
| Lighting In <b>Green</b>                         | Simultaneous blinking in <b>Red</b> |                        | <b>It is time to clean the air filter.</b><br>Please immediately turn the power OFF, and clean or change the air filter by referring to the section "Air Filter". After cleaning or changed the air filter, please be sure to reset the filter timer. After the treatment, resent the power to ON.   |

**NOTE** • When the interior portion has become overheated, for safety purposes, the power source is automatically turned off, and the indicator lamps may also be turned off. In such a case, press the "O" (OFF) side of the power switch, and wait at least 45 minutes. After the projector has sufficiently cooled down, please make confirmation of the attachment state of the lamp and lamp cover, and then turn the power on again.



## Phenomena that may easily be mistaken for machine defects

**⚠ WARNING** ▶ Never use the projector if abnormal operations such as smoke, strange odor, excessive sound, damaged casing or elements or cables, penetration of liquids or foreign matter, etc. should occur. In such cases, immediately turn off the power switch and then disconnect the power plug from the power outlet. After making sure that the smoke or odor has stopped, contact your dealer or service company.

1. Before requesting repair, please check in accordance with the following chart. This operation sometimes resolves your problem.

If the situation cannot be corrected,

2. The projector's microprocessor may need to be reset. Please push the Restart switch by using a cocktail stick or similar and the projector will restart.
3. Some setting may be wrong. Please use the FACTORY RESET function of SERVICE menu in the OPTION menu (🔑39) to reset all settings to factory default.

Then, if the problem is not removed after maintenance, please contact your dealer or service company.

| Phenomenon              | Cases not involving a machine defect  | Reference page |
|-------------------------|---|----------------|
| Power does not come on. | <b>The electrical power cord is not plugged in.</b><br>Correctly connect the power cord.  | 13             |
|                         | <b>The power switch is not set to the on position.</b><br>Set the power switch to [   ] (On).   | 16             |
|                         | <b>The main power source has been interrupted during operation such as by a power outage (blackout), etc.</b><br>Please turn the power off, and allow the unit to cool down at least 20 minutes. After the projector has sufficiently cooled down, please turn the power on again.  | 16             |
|                         | <b>Either there is no lamp and/or lamp cover, or either of these has not been properly fixed.</b><br>Please turn the power off, and allow the unit to cool down at least 45 minutes. After the projector has sufficiently cooled down, please make confirmation of the attachment state of the lamp and lamp cover, and then turn the power on again. | 44, 45         |

**Phenomena that may easily be mistaken for machine defects (continued)**

| Phenomenon  | Cases not involving a machine defect   | Reference page |
|---|--|----------------|
| No pictures are displayed.                                  | <b>The lens cap is attached.</b><br>Remove the lens cap.   | 4, 16          |
|   | <b>The signal cables are not correctly connected.</b><br>Correctly connect the connection cables.  | 10             |
|   | <b>The brightness is adjusted to an extremely low level.</b><br>Adjust the BRIGHT to a higher level using the menu function or the remote control.                                 | 24, 26         |
|   | <b>The computer cannot detect the projector as a plug and play monitor.</b><br>Make sure that the computer's can detect a plug and play monitor using other plug and play monitor. | 10             |
| Colors have a faded- out appearance, or Color tone is poor. | <b>Color settings are not correctly adjusted.</b><br>Perform picture adjustments by changing the COLOR TEMP, COLOR, TINT and/or COLOR SPACE settings, using the menu functions.    | 24, 27, 32     |
|   | <b>COLOR SPACE setting is not suitable.</b><br>Change the COLOR SPACE setting to AUTO, RGB, SMPTE240, REC709 or REC601.  | 32             |
| Pictures appear dark.                                       | <b>The brightness and/or contrast are adjusted to an extremely low level.</b><br>Adjust the BRIGHT and/or CONTRAST settings to a higher level using the menu function.             | 24, 26         |
|   | <b>The WHISPER function is working.</b><br>Select the NORMAL to the item WHISPER in the SETUP menu.  | 24, 34         |
|   | <b>The lamp is approaching the end of its product lifetime.</b><br>Replace the lamp.   | 44, 45         |
| Pictures appear blurry.                                     | <b>Either the focus and/or horizontal phase settings are not properly.</b><br>Adjust the focus using the focus ring, and/or H PHASE using the menu function.                       | 18, 29         |
|   | <b>The lens is dirty or misty.</b><br>Clean the lens by referring to the section "Caring for the lens".  | 47             |

**NOTE** • Although bright spots or dark spots may appear on the screen, this is a unique characteristic of liquid crystal displays, and such do not constitute or imply a machine defect.

## Warranty and after-service

If a problem occurs with the equipment, first refer to the “Troubleshooting” and run through the suggested checks. If this does not resolve the problem, please contact your dealer or the service company. They will tell you what warranty condition is applied.

### Specifications

## Specifications

**NOTE** • This specifications are subject to change without notice.

| Item                 |              | Specification   |
|----------------------|--------------|---|
| Product name         |              | Liquid crystal projector  |
| Liquid Crystal panel | Panel size   | 2.0 cm (0.79 type)  |
|                      | Drive system | TFT active matrix   |
|                      | Pixels       | 786,432 pixels (1024 horizontal x 768 vertical)   |
| Lens                 |              | Zoom lens F=1.7 ~ 2.0 f=24.4 ~ 29.2 mm  |
| Lamp                 |              | 230W UHB  |
| Speaker              |              | 3W x 4  |
| Power Supply         |              | AC100-120V/4.2A, AC220-240V/2.1A  |
| Power Consumption    |              | 370W  |
| Temperature range    |              | 5 ~ 35°C (Operating)  |
| Size                 |              | 336 (W) x 95 (H) x 265 (D) mm<br>(Not including protruding parts)<br>• Please refer to the following figure.  |
| Weight (mass)        |              | 3.9 kg  |
| Ports                |              | <b>DIGITAL RGB input:</b><br>DVI-D ..... 1<br><b>RGB input:</b><br>RGB IN1 ..D-sub 15pin mini x1<br>RGB IN2 ..D-sub 15pin mini x1<br><b>RGB output:</b><br>RGB OUT D-sub 15pin mini x1<br><b>Audio input:</b><br>AUDIO IN ..... Stereo mini x1<br>AUDIO IN L/R..... RCA x2<br><b>Audio output:</b><br>AUDIO OUT ... Stereo mini x1<br><b>Video input:</b><br>COMPONENT VIDEO<br>(Y, Cb/Pb, Cr/Pr)..... RCA x3<br>S-Video ..... 1<br>Video ..... 1<br><b>Communication port:</b><br>CONTROL..... D-sub 9pin x1<br>USB ..... USB(B) x1<br>LAN ..... RJ45 x1<br><b>Other port:</b><br>WIRED REMOTE ..... x1<br>DC OUT.....x1 |
| Optional parts       | Lamp         | 456-8915  |
|                      | Air filter   | NJ20642   |
|                      | Others       | • Please consult your dealer.   |

Specifications (continued)

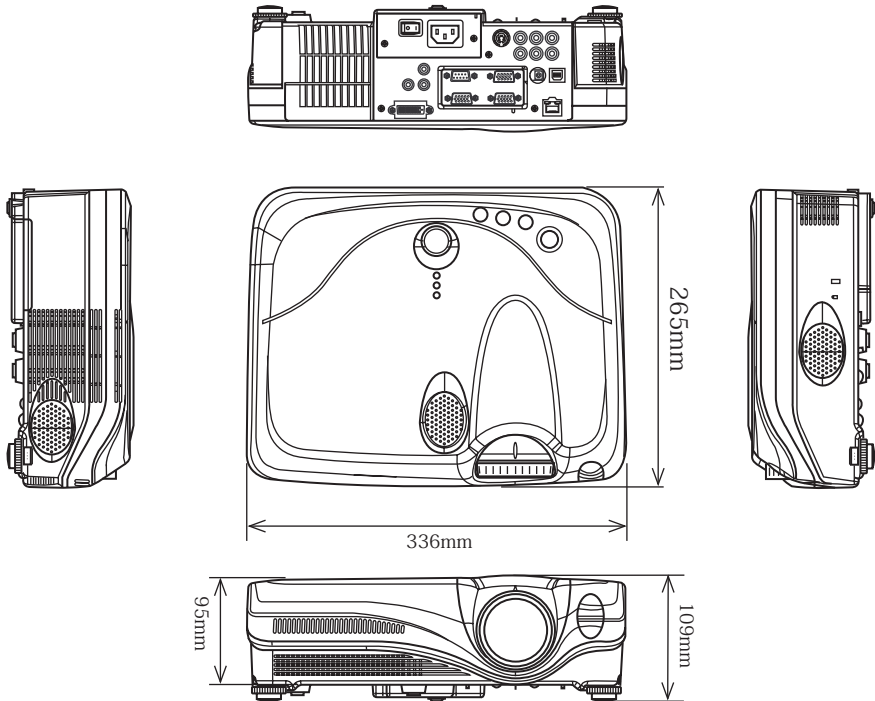



## Projector

# ImagePro 8915

## User's Manual – Operating Guide

### Technical

#### Example of computer signal

| Resolution (H x V) | H. frequency (kHz) | V. frequency (Hz) | Rating | Signal mode  |
|--------------------|--------------------|-------------------|--------|--------------|
| 720 x 400          | 37.9               | 85.0              | VESA   | TEXT         |
| 640 x 480          | 31.5               | 59.9              | VESA   | VGA (60Hz)   |
| 640 x 480          | 37.9               | 72.8              | VESA   | VGA (72Hz)   |
| 640 x 480          | 37.5               | 75.0              | VESA   | VGA (75Hz)   |
| 640 x 480          | 43.3               | 85.0              | VESA   | VGA (75Hz)   |
| 800 x 600          | 35.2               | 56.3              | VESA   | SVGA (56Hz)  |
| 800 x 600          | 37.9               | 60.3              | VESA   | SVGA (60Hz)  |
| 800 x 600          | 48.1               | 72.2              | VESA   | SVGA (72Hz)  |
| 800 x 600          | 46.9               | 75.0              | VESA   | SVGA (75Hz)  |
| 800 x 600          | 53.7               | 85.1              | VESA   | SVGA (85Hz)  |
| 832 x 624          | 49.7               | 74.5              |        | Mac 16" mode |
| 1024 x 768         | 48.4               | 60.0              | VESA   | XGA (60Hz)   |
| 1024 x 768         | 56.5               | 70.1              | VESA   | XGA (70Hz)   |
| 1024 x 768         | 60.0               | 75.0              | VESA   | XGA (75Hz)   |
| 1024 x 768         | 68.7               | 85.0              | VESA   | XGA (75Hz)   |
| 1152 x 864         | 67.5               | 75.0              | VESA   | SXGA (75Hz)  |
| 1280 x 960         | 60.0               | 60.0              | VESA   | SXGA (60Hz)  |
| 1280 x 1024        | 64.0               | 60.0              | VESA   | SXGA (60Hz)  |
| 1280 x 1024        | 80.0               | 75.0              | VESA   | SXGA (75Hz)  |
| 1280 x 1024        | 91.2               | 85.0              | VESA   | SXGA (85Hz)  |
| 1600 x 1200        | 75.0               | 60.0              | VESA   | UXGA (60Hz)  |

- NOTE** • Be sure to check jack type, signal level, timing and resolution before connecting this projector to a computer.
- Some computers may have multiple display screen modes. Use of some of these modes will not be possible with this projector.
  - Depending on the input signal, full-size display may not be possible in some cases. Refer to the number of display pixels above.
  - Although the projector can display signals with resolution up to UXGA (1600x1200), the signal will be converted to the projector's panel resolution before being displayed. The best display performance will be achieved if the resolutions of the input signal and projector panel are identical.
  - Automatically adjustment may not function correctly with some input signals.
  - The image may not be displayed correctly when the input sync signal is a composite sync or a sync on G.

## Initial set signals

The following signals are used for the initial settings. The signal timing of some computer models may be different. In such case, adjust the items V POSITION and H POSITION in the IMAGE menu.

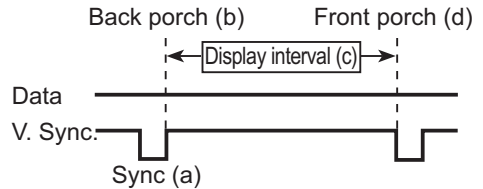
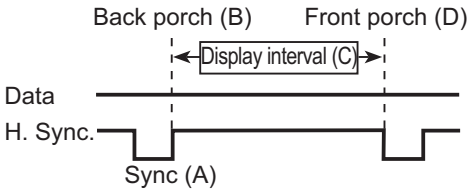

| Computer/<br>Signal   | Horizontal signal timing (μs) |     |      |     |
|-----------------------|-------------------------------|-----|------|-----|
|                       | (A)                           | (B) | (C)  | (D) |
| TEXT                  | 2.0                           | 3.0 | 20.3 | 1.0 |
| VGA (60Hz)            | 3.8                           | 1.9 | 25.4 | 0.6 |
| VGA (72Hz)            | 1.3                           | 3.8 | 20.3 | 1.0 |
| VGA (75Hz)            | 2.0                           | 3.8 | 20.3 | 0.5 |
| VGA (85Hz)            | 1.6                           | 2.2 | 17.8 | 1.6 |
| SVGA (56Hz)           | 2.0                           | 3.6 | 22.2 | 0.7 |
| SVGA (60Hz)           | 3.2                           | 2.2 | 20.0 | 1.0 |
| SVGA (72Hz)           | 2.4                           | 1.3 | 16.0 | 1.1 |
| SVGA (75Hz)           | 1.6                           | 3.2 | 16.2 | 0.3 |
| SVGA (85Hz)           | 1.1                           | 2.7 | 14.2 | 0.6 |
| Mac 16" mode          | 1.1                           | 3.9 | 14.5 | 0.6 |
| XGA (60Hz)            | 2.1                           | 2.5 | 15.8 | 0.4 |
| XGA (70Hz)            | 1.8                           | 1.9 | 13.7 | 0.3 |
| XGA (75Hz)            | 1.2                           | 2.2 | 13.0 | 0.2 |
| XGA (85Hz)            | 1.0                           | 2.2 | 10.8 | 0.5 |
| 1152 x 864<br>(75Hz)  | 1.2                           | 2.4 | 10.7 | 0.6 |
| 1280 x 960<br>(60Hz)  | 1.0                           | 2.9 | 11.9 | 0.9 |
| 1280 x 1024<br>(60Hz) | 1.0                           | 2.3 | 11.9 | 0.4 |
| 1280 x 1024<br>(75Hz) | 1.1                           | 1.8 | 9.5  | 0.2 |
| 1280 x 1024<br>(85Hz) | 1.0                           | 1.4 | 8.1  | 0.4 |
| 1600 x 1200<br>(60Hz) | 1.2                           | 1.9 | 9.9  | 0.4 |

| Computer/<br>Signal   | Vertical signal timing (lines) |     |      |     |
|-----------------------|--------------------------------|-----|------|-----|
|                       | (a)                            | (b) | (c)  | (d) |
| TEXT                  | 3                              | 42  | 400  | 1   |
| VGA (60Hz)            | 2                              | 33  | 480  | 10  |
| VGA (72Hz)            | 3                              | 28  | 480  | 9   |
| VGA (75Hz)            | 3                              | 16  | 480  | 1   |
| VGA (85Hz)            | 3                              | 25  | 480  | 1   |
| SVGA (56Hz)           | 2                              | 22  | 600  | 1   |
| SVGA (60Hz)           | 4                              | 23  | 600  | 1   |
| SVGA (72Hz)           | 6                              | 23  | 600  | 37  |
| SVGA (75Hz)           | 3                              | 21  | 600  | 1   |
| SVGA (85Hz)           | 3                              | 27  | 600  | 1   |
| Mac 16" mode          | 3                              | 39  | 624  | 1   |
| XGA (60Hz)            | 6                              | 29  | 768  | 3   |
| XGA (70Hz)            | 6                              | 29  | 768  | 3   |
| XGA (75Hz)            | 3                              | 28  | 768  | 1   |
| XGA (85Hz)            | 3                              | 36  | 768  | 1   |
| 1152 x 864<br>(75Hz)  | 3                              | 32  | 864  | 1   |
| 1280 x 960<br>(60Hz)  | 3                              | 36  | 960  | 1   |
| 1280 x 1024<br>(60Hz) | 3                              | 38  | 1024 | 1   |
| 1280 x 1024<br>(75Hz) | 3                              | 37  | 1024 | 2   |
| 1280 x 1024<br>(85Hz) | 3                              | 44  | 1024 | 1   |
| 1600 x 1200<br>(60Hz) | 3                              | 46  | 1200 | 1   |

Connection to the ports

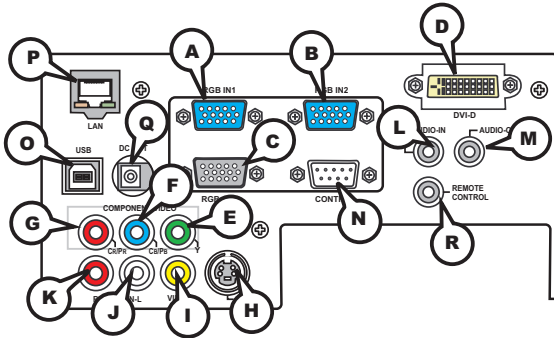

**A) RGB IN 1, B) RGB IN 2, C) RGB OUT**

D-sub 15pin mini shrink jack

- Video signal: RGB separate, Analog, 0.7Vp-p, 75Ω terminated (positive)
- H/V. sync. Signal: TTL level (positive/negative)
- Composite sync. Signal: TTL level

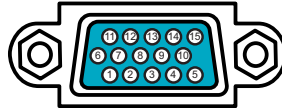

At RGB signal

At component video signal

| Pin | Signal  |
|-----|---|
| 1   | Video Red   |
| 2   | Video Green   |
| 3   | Video Blue  |
| 4   | (No connection)   |
| 5   | Ground  |
| 6   | Ground Red  |
| 7   | Ground Green  |
| 8   | Ground Blue   |
| 9   | (No connection)   |
| 10  | Ground  |
| 11  | (No connection)   |
| 12  | <b>A)</b> : SDA (DDC data), <b>B)/C)</b> : (No connection)  |
| 13  | H. sync / Composite sync.                                   |
| 14  | V. sync.  |
| 15  | <b>A)</b> : SCL (DDC clock), <b>B)/C)</b> : (No connection) |

| Pin | Signal                                |
|-----|---------------------------------------|
| 1   | C <sub>R</sub> /P <sub>R</sub>        |
| 2   | Y                                     |
| 3   | C <sub>B</sub> /P <sub>B</sub>        |
| 4   | (No connection)                       |
| 5   | Ground                                |
| 6   | C <sub>R</sub> /P <sub>R</sub> Ground |
| 7   | Y Ground                              |
| 8   | C <sub>B</sub> /P <sub>B</sub> Ground |
| 9   | (No connection)                       |
| 10  | Ground                                |
| 11  | (No connection)                       |
| 12  |                                       |
| 13  |                                       |
| 15  |                                       |

\* except for RGB OUT.



## Connection to the ports

### ⓓ DVI -D

DVI-D jack (digital to digital)

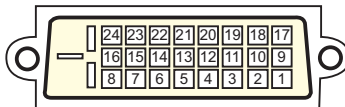

| Pin | Signal                   | Pin | Signal                        |
|-----|--------------------------|-----|-------------------------------|
| 1   | T.M.D.S. Data 2 -        | 13  | -                             |
| 2   | T.M.D.S. Data 2 +        | 14  | +5V Power                     |
| 3   | T.M.D.S. Data 2/4 Shield | 15  | Ground (+5V, Analog H/V.sync) |
| 4   | -                        | 16  | Hot-Plug Sense                |
| 5   | -                        | 17  | T.M.D.S. Data 0 -             |
| 6   | SCL (DDC Clock)          | 18  | T.M.D.S. Data 0 +             |
| 7   | SDA (DDC Data)           | 19  | T.M.D.S. Data 0/5 Shield      |
| 8   | Analog V. sync           | 20  | -                             |
| 9   | T.M.D.S. Data 1 -        | 21  | -                             |
| 10  | T.M.D.S. Data 1 +        | 22  | T.M.D.S. Clock Shield         |
| 11  | T.M.D.S. Data 1/3 Shield | 23  | T.M.D.S. Clock +              |
| 12  | -                        | 24  | T.M.D.S. Clock -              |

### ⓔY, ⓕCB/PB, ⓐCR/PR

RCA jack x3

- System: 525i(480i), 525p(480p), 625i(576i), 750p(720p), 1125i(1080i)

| Port  | Signal  |
|-------|---|
| Y     | Component video Y, 1.0±0.1Vp-p, 75Ω terminator with composite |
| CB/PB | Component video CB/PB, 0.7±0.1Vp-p, 75Ω terminator            |
| CR/PR | Component video CR/PR, 0.7±0.1Vp-p, 75Ω terminator            |

### ⓓS-VIDEO

Mini DIN 4pin jack



| Pin | Signal   |
|-----|--|
| 1   | Color signal 0.286Vp-p (NTSC, burst), 75Ω terminator<br>Color signal 0.300Vp-p (PAL/SECAM, burst) 75Ω terminator |
| 2   | Brightness signal, 1.0Vp-p, 75Ω terminator   |
| 3   | Ground   |
| 4   | Ground   |

### ⓓVIDEO

RCA jack

- System: NTSC, PAL, SECAM, PAL-M, PAL-N, NTSC4.43, PAL60
- 1.0±0.1Vp-p, 75Ω terminator

**L**AUDIO IN (Ø3.5 stereo mini jack), **J****K**AUDIO INL/R (RCA jack)

- 200mVrms(max.) 50kΩ termination

**M**AUDIO OUT (Ø3.5 stereo mini jack)

- 200mVrms(max.) 1kΩ output impedance

**O**USB

USB B type jack



| Pin | Signal |
|-----|--------|
| 1   | +5V    |
| 2   | - Data |
| 3   | + Data |
| 4   | Ground |

**N**CONTROL

D-sub 9pin plug

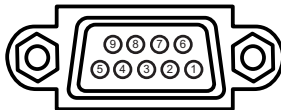

- About the details of RS-232C communication, please refer to the following page.

| Pin | Signal          | Pin | Signal          | Pin | Signal          |
|-----|-----------------|-----|-----------------|-----|-----------------|
| 1   | (No connection) | 4   | (No connection) | 7   | RTS             |
| 2   | RD              | 5   | Ground          | 8   | CTS             |
| 3   | TD              | 6   | (No connection) | 9   | (No connection) |

**P**LAN

RJ45 jack

**Q**DC OUT

DC5V/1.5A(max.)

**R**WIRED REMOTE

Ø3.5mm Stereo Mini jack

- To be connected with the remote control that came with the projector.

## RS-232C Communication

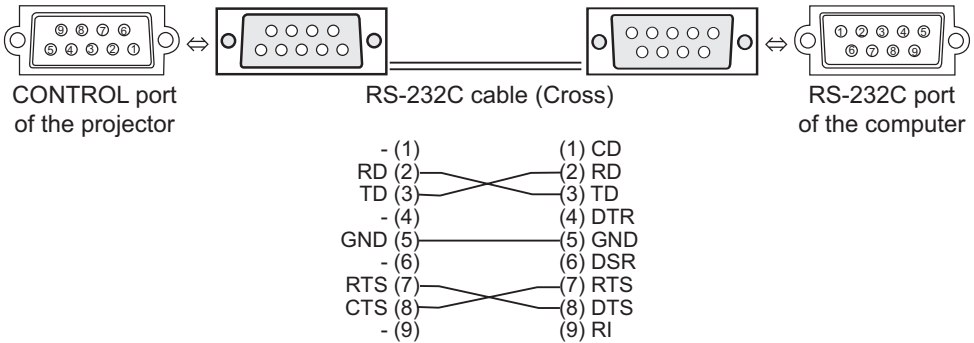

### Connecting the cable

1. Turn off the projector and the computer.
2. Connect the CONTROL port of the projector with a RS-232C port of the computer by a RS-232C cable (cross). Use the cable that fulfills the specification shown in the previous page.
3. Turn the computer on, and after the computer has started up turn the projector on.

### Communications setting

19200bps, 8N1

#### 1. Protocol

Consist of header (7 bytes) + command data (6 bytes).

#### 2. Header

BE + EF + 03 + 06 + 00 + CRC\_low + CRC\_high

CRC\_low : Lower byte of CRC flag for command data

CRC\_high : Upper byte of CRC flag for command data

#### 3. Command data

Command data chart

| byte_0 | byte_1 | byte_2 | byte_3 | byte_4       | byte_5 |
|--------|--------|--------|--------|--------------|--------|
| Action |        | Type   |        | Setting code |        |
| low    | high   | low    | high   | low          | high   |

Action (byte\_0 - 1)

| Action | Classification | Content                              |
|--------|----------------|--------------------------------------|
| 1      | SET            | Change setting to desired value.     |
| 2      | GET            | Read projector internal setup value. |
| 4      | INCREMENT      | Increment setup value by 1.          |
| 5      | DECREMENT      | Decrement setup value by 1.          |
| 6      | EXECUTE        | Run a command.                       |

**Requesting projector status (Get command)**

- (1) Send the request code Header + Command data ('02H'+ '00H'+ type (2 bytes)+ '00H' + '00H') from the computer to the projector.
- (2) The projector returns the response code '1DH'+ data (2 bytes) to the computer.

**Changing the projector settings (Set command)**

- (1) Send the setting code Header + Command data ('01H'+ '00H'+ type (2 bytes) + setting code (2 bytes)) from the computer to the projector.
- (2) The projector changes the setting based on the above setting code.
- (3) The projector returns the response code '06H' to the computer.

**Using the projector default settings (Reset Command)**

- (1) The computer sends the default setting code Header + Command data ('06H'+ '00H' + type (2 bytes) + '00H'+ '00H') to the projector.
- (2) The projector changes the specified setting to the default value.
- (3) The projector returns the response code '06H' to the computer.

**Increasing the projector setting value (Increment command)**

- (1) The computer sends the increment code Header + Command data ('04H'+ '00H'+ type (2 bytes) + '00H'+ '00H') to the projector.
- (2) The projector increases the setting value on the above setting code.
- (3) The projector returns the response code '06H' to the computer.

**Decreasing the projector setting value (Decrement command)**

- (1) The computer sends the decrement code Header + Command data ('05H'+ '00H'+ type (2 bytes) + '00H' + '00H') to the projector.
- (2) The projector decreases the setting value on the above setting code.
- (3) The projector returns the response code '06H' to the computer.

**When the projector cannot understand the received command**

When the projector cannot understand the received command, the error code '15H' is sent back to the computer.

Sometimes the projector cannot properly receive the command. In such a case, the command is not executed and the error code '15H' is sent back to the computer. If this error code is returned, send the same command again.

**When the projector cannot execute the received command.**

When the projector cannot execute the received command, the error code '1cH' + 'xxxxH' is sent back to the computer. When the data length is greater than indicated by the data length code, the projector ignore the excess data code.

Conversely when the data length is shorter than indicated by the data length code, an error code will be returned to the computer.

**NOTE** • Operation cannot be guaranteed when the projector receives an undefined command or data.

- Provide an interval of at least 40ms between the response code and any other code.
- The projector outputs test data when the power supply is switched ON, and when the lamp is lit. Ignore this data.
- Commands are not accepted during warm-up.

RS-232C Communication (continued)

| Names          | Operation Type   | Header            |                   |                        |                      | Command Data          |                       |                           |                            |
|----------------|------------------|-------------------|-------------------|------------------------|----------------------|-----------------------|-----------------------|---------------------------|----------------------------|
|                |                  |                   |                   |                        | CRC                  | Action                | Type                  | Setting Code              |                            |
| Power          | Set              | Turn off          | BE EF             | 03                     | 06 00                | 2A D3                 | 01 00                 | 00 60                     | 00 00                      |
|                |                  | Turn on           | BE EF             | 03                     | 06 00                | BA D2                 | 01 00                 | 00 60                     | 01 00                      |
|                | Get              |                   | BE EF             | 03                     | 06 00                | 19 D3                 | 02 00                 | 00 60                     | 00 00                      |
|                |                  | (Example return)  | 00 00<br>(Off)    | 01 00<br>(On)          | 02 00<br>(Cool down) |                       |                       |                           |                            |
| Input Source   | Set              | DVI               | BE EF             | 03                     | 06 00                | 0E D2                 | 01 00                 | 00 20                     | 03 00                      |
|                |                  | RGB IN 1          | BE EF             | 03                     | 06 00                | FE D2                 | 01 00                 | 00 20                     | 00 00                      |
|                |                  | RGB IN 2          | BE EF             | 03                     | 06 00                | 3E D0                 | 01 00                 | 00 20                     | 04 00                      |
|                |                  | VIDEO             | BE EF             | 03                     | 06 00                | 6E D3                 | 01 00                 | 00 20                     | 01 00                      |
|                |                  | S-VIDEO           | BE EF             | 03                     | 06 00                | 9E D3                 | 01 00                 | 00 20                     | 02 00                      |
|                | COMPONENT        | BE EF             | 03                | 06 00                  | AE D1                | 01 00                 | 00 20                 | 05 00                     |                            |
|                | Get              | BE EF             | 03                | 06 00                  | CD D2                | 02 00                 | 00 20                 | 00 00                     |                            |
| Error Status   | Get              |                   | BE EF             | 03                     | 06 00                | D9 D8                 | 02 00                 | 20 60                     | 00 00                      |
|                |                  | (Example return)  | 00 00<br>(Normal) | 01 00<br>(Cover error) | 02 00<br>(Fan error) | 03 00<br>(Lamp error) | 04 00<br>(Temp error) | 05 00<br>(Air flow error) | 06 00<br>(Lamp time error) |
| BRIGHT         | Get              |                   | BE EF             | 03                     | 06 00                | 89 D2                 | 02 00                 | 03 20                     | 00 00                      |
|                |                  | Increment         | BE EF             | 03                     | 06 00                | EF D2                 | 04 00                 | 03 20                     | 00 00                      |
|                |                  | Decrement         | BE EF             | 03                     | 06 00                | 3E D3                 | 05 00                 | 03 20                     | 00 00                      |
| BRIGHT Reset   | Execute          | BE EF             | 03                | 06 00                  | 58 D3                | 06 00                 | 00 70                 | 00 00                     |                            |
| CONTRAST       | Get              |                   | BE EF             | 03                     | 06 00                | FD D3                 | 02 00                 | 04 20                     | 00 00                      |
|                |                  | Increment         | BE EF             | 03                     | 06 00                | 9B D3                 | 04 00                 | 04 20                     | 00 00                      |
|                |                  | Decrement         | BE EF             | 03                     | 06 00                | 4A D2                 | 05 00                 | 04 20                     | 00 00                      |
| CONTRAST Reset | Execute          | BE EF             | 03                | 06 00                  | A4 D2                | 06 00                 | 01 70                 | 00 00                     |                            |
| MODE           | Set              | NORMAL            | BE EF             | 03                     | 06 00                | 23 F6                 | 01 00                 | BA 30                     | 00 00                      |
|                |                  | CINEMA            | BE EF             | 03                     | 06 00                | B3 F7                 | 01 00                 | BA 30                     | 01 00                      |
|                |                  | DYNAMIC           | BE EF             | 03                     | 06 00                | E3 F4                 | 01 00                 | BA 30                     | 04 00                      |
|                | Get              | BE EF             | 03                | 06 00                  | 10 F6                | 02 00                 | BA 30                 | 00 00                     |                            |
|                | (Example return) | 00 00<br>(Normal) | 01 00<br>(Cinema) | 04 00<br>(Dynamic)     | 10 00<br>(Custom)    |                       |                       |                           |                            |
| GAMMA          | Set              | #1 DEFAULT        | BE EF             | 03                     | 06 00                | 07 E9                 | 01 00                 | A1 30                     | 20 00                      |
|                |                  | #1 CUSTOM         | BE EF             | 03                     | 06 00                | 07 FD                 | 01 00                 | A1 30                     | 10 00                      |
|                |                  | #2 DEFAULT        | BE EF             | 03                     | 06 00                | 97 E8                 | 01 00                 | A1 30                     | 21 00                      |
|                |                  | #2 CUSTOM         | BE EF             | 03                     | 06 00                | 97 FC                 | 01 00                 | A1 30                     | 11 00                      |
|                |                  | #3 DEFAULT        | BE EF             | 03                     | 06 00                | 67 E8                 | 01 00                 | A1 30                     | 22 00                      |
|                |                  | #3 CUSTOM         | BE EF             | 03                     | 06 00                | 67 FC                 | 01 00                 | A1 30                     | 12 00                      |
|                | Get              | BE EF             | 03                | 06 00                  | F4 F0                | 02 00                 | A1 30                 | 00 00                     |                            |

| Names              | Operation Type | Header              |       |       |       | Command Data |        |       |              |
|--------------------|----------------|---------------------|-------|-------|-------|--------------|--------|-------|--------------|
|                    |                |                     |       |       |       | CRC          | Action | Type  | Setting Code |
| User Gamma Pattern | Set            | Off                 | BE EF | 03    | 06 00 | FB FA        | 01 00  | 80 30 | 00 00        |
|                    |                | 9 step gray scale   | BE EF | 03    | 06 00 | 6B FB        | 01 00  | 80 30 | 01 00        |
|                    |                | 15 steps gray scale | BE EF | 03    | 06 00 | 9B FB        | 01 00  | 80 30 | 02 00        |
|                    |                | Ramp                | BE EF | 03    | 06 00 | 0B FA        | 01 00  | 80 30 | 03 00        |
|                    | Get            | BE EF               | 03    | 06 00 | C8 FA | 02 00        | 80 30  | 00 00 |              |
| User Gamma Point 1 | Get            | BE EF               | 03    | 06 00 | 08 FE | 02 00        | 90 30  | 00 00 |              |
|                    | Increment      | BE EF               | 03    | 06 00 | 6E FE | 04 00        | 90 30  | 00 00 |              |
|                    | Decrement      | BE EF               | 03    | 06 00 | BF FF | 05 00        | 90 30  | 00 00 |              |
| User Gamma Point 2 | Get            | BE EF               | 03    | 06 00 | F4 FF | 02 00        | 91 30  | 00 00 |              |
|                    | Increment      | BE EF               | 03    | 06 00 | 92 FF | 04 00        | 91 30  | 00 00 |              |
|                    | Decrement      | BE EF               | 03    | 06 00 | 43 FE | 05 00        | 91 30  | 00 00 |              |
| User Gamma Point 3 | Get            | BE EF               | 03    | 06 00 | B0 FF | 02 00        | 92 30  | 00 00 |              |
|                    | Increment      | BE EF               | 03    | 06 00 | D6 FF | 04 00        | 92 30  | 00 00 |              |
|                    | Decrement      | BE EF               | 03    | 06 00 | 07 FE | 05 00        | 92 30  | 00 00 |              |
| User Gamma Point 4 | Get            | BE EF               | 03    | 06 00 | 4C FE | 02 00        | 93 30  | 00 00 |              |
|                    | Increment      | BE EF               | 03    | 06 00 | 2A FE | 04 00        | 93 30  | 00 00 |              |
|                    | Decrement      | BE EF               | 03    | 06 00 | FB FF | 05 00        | 93 30  | 00 00 |              |
| User Gamma Point 5 | Get            | BE EF               | 03    | 06 00 | 38 FF | 02 00        | 94 30  | 00 00 |              |
|                    | Increment      | BE EF               | 03    | 06 00 | 5E FF | 04 00        | 94 30  | 00 00 |              |
|                    | Decrement      | BE EF               | 03    | 06 00 | 8F FE | 05 00        | 94 30  | 00 00 |              |
| User Gamma Point 6 | Get            | BE EF               | 03    | 06 00 | C4 FE | 02 00        | 95 30  | 00 00 |              |
|                    | Increment      | BE EF               | 03    | 06 00 | A2 FE | 04 00        | 95 30  | 00 00 |              |
|                    | Decrement      | BE EF               | 03    | 06 00 | 73 FF | 05 00        | 95 30  | 00 00 |              |
| User Gamma Point 7 | Get            | BE EF               | 03    | 06 00 | 80 FE | 02 00        | 96 30  | 00 00 |              |
|                    | Increment      | BE EF               | 03    | 06 00 | E6 FE | 04 00        | 96 30  | 00 00 |              |
|                    | Decrement      | BE EF               | 03    | 06 00 | 37 FF | 05 00        | 96 30  | 00 00 |              |
| User Gamma Point 8 | Get            | BE EF               | 03    | 06 00 | 7C FF | 02 00        | 97 30  | 00 00 |              |
|                    | Increment      | BE EF               | 03    | 06 00 | 1A FF | 04 00        | 97 30  | 00 00 |              |
|                    | Decrement      | BE EF               | 03    | 06 00 | CB FE | 05 00        | 97 30  | 00 00 |              |
| COLOR TEMP         | Set            | LOW                 | BE EF | 03    | 06 00 | 6B F4        | 01 00  | B0 30 | 01 00        |
|                    |                | MIDDLE              | BE EF | 03    | 06 00 | 9B F4        | 01 00  | B0 30 | 02 00        |
|                    |                | HIGH                | BE EF | 03    | 06 00 | 0B F5        | 01 00  | B0 30 | 03 00        |
|                    |                | CUSTOM              | BE EF | 03    | 06 00 | 3B F8        | 01 00  | B0 30 | 10 00        |
|                    | Get            | BE EF               | 03    | 06 00 | C8 F5 | 02 00        | B0 30  | 00 00 |              |
| COLOR TEMP GAIN R  | Get            | BE EF               | 03    | 06 00 | 34 F4 | 02 00        | B1 30  | 00 00 |              |
|                    | Increment      | BE EF               | 03    | 06 00 | 52 F4 | 04 00        | B1 30  | 00 00 |              |
|                    | Decrement      | BE EF               | 03    | 06 00 | 83 F5 | 05 00        | B1 30  | 00 00 |              |

RS-232C Communication (continued)

| Names               | Operation Type | Header |       |       |       | Command Data |        |       |              |
|---------------------|----------------|--------|-------|-------|-------|--------------|--------|-------|--------------|
|                     |                |        |       |       |       | CRC          | Action | Type  | Setting Code |
| COLOR TEMP GAIN G   | Get            | BE EF  | 03    | 06 00 | 70 F4 | 02 00        | B2 30  | 00 00 |              |
|                     | Increment      | BE EF  | 03    | 06 00 | 16 F4 | 04 00        | B2 30  | 00 00 |              |
|                     | Decrement      | BE EF  | 03    | 06 00 | C7 F5 | 05 00        | B2 30  | 00 00 |              |
| COLOR TEMP GAIN B   | Get            | BE EF  | 03    | 06 00 | 8C F5 | 02 00        | B3 30  | 00 00 |              |
|                     | Increment      | BE EF  | 03    | 06 00 | EA F5 | 04 00        | B3 30  | 00 00 |              |
|                     | Decrement      | BE EF  | 03    | 06 00 | 3B F4 | 05 00        | B3 30  | 00 00 |              |
| COLOR TEMP OFFSET R | Get            | BE EF  | 03    | 06 00 | 04 F5 | 02 00        | B5 30  | 00 00 |              |
|                     | Increment      | BE EF  | 03    | 06 00 | 62 F5 | 04 00        | B5 30  | 00 00 |              |
|                     | Decrement      | BE EF  | 03    | 06 00 | B3 F4 | 05 00        | B5 30  | 00 00 |              |
| COLOR TEMP OFFSET G | Get            | BE EF  | 03    | 06 00 | 40 F5 | 02 00        | B6 30  | 00 00 |              |
|                     | Increment      | BE EF  | 03    | 06 00 | 26 F5 | 04 00        | B6 30  | 00 00 |              |
|                     | Decrement      | BE EF  | 03    | 06 00 | F7 F4 | 05 00        | B6 30  | 00 00 |              |
| COLOR TEMP OFFSET B | Get            | BE EF  | 03    | 06 00 | BC F4 | 02 00        | B7 30  | 00 00 |              |
|                     | Increment      | BE EF  | 03    | 06 00 | DA F4 | 04 00        | B7 30  | 00 00 |              |
|                     | Decrement      | BE EF  | 03    | 06 00 | 0B F5 | 05 00        | B7 30  | 00 00 |              |
| COLOR               | Get            | BE EF  | 03    | 06 00 | B5 72 | 02 00        | 02 22  | 00 00 |              |
|                     | Increment      | BE EF  | 03    | 06 00 | D3 72 | 04 00        | 02 22  | 00 00 |              |
|                     | Decrement      | BE EF  | 03    | 06 00 | 02 73 | 05 00        | 02 22  | 00 00 |              |
| COLOR Reset         | Execute        | BE EF  | 03    | 06 00 | 80 D0 | 06 00        | 0A 70  | 00 00 |              |
| TINT                | Get            | BE EF  | 03    | 06 00 | 49 73 | 02 00        | 03 22  | 00 00 |              |
|                     | Increment      | BE EF  | 03    | 06 00 | 2F 73 | 04 00        | 03 22  | 00 00 |              |
|                     | Decrement      | BE EF  | 03    | 06 00 | FE 72 | 05 00        | 03 22  | 00 00 |              |
| TINT Reset          | Execute        | BE EF  | 03    | 06 00 | 7C D1 | 06 00        | 0B 70  | 00 00 |              |
| SHARPNESS           | Get            | BE EF  | 03    | 06 00 | F1 72 | 02 00        | 01 22  | 00 00 |              |
|                     | Increment      | BE EF  | 03    | 06 00 | 97 72 | 04 00        | 01 22  | 00 00 |              |
|                     | Decrement      | BE EF  | 03    | 06 00 | 46 73 | 05 00        | 01 22  | 00 00 |              |
| SHARPNESS Reset     | Execute        | BE EF  | 03    | 06 00 | C4 D0 | 06 00        | 09 70  | 00 00 |              |
| MY MEMORY Load      | Set            | 1      | BE EF | 03    | 06 00 | 0E D7        | 01 00  | 14 20 | 00 00        |
|                     |                | 2      | BE EF | 03    | 06 00 | 9E D6        | 01 00  | 14 20 | 01 00        |
|                     |                | 3      | BE EF | 03    | 06 00 | 6E D6        | 01 00  | 14 20 | 02 00        |
|                     |                | 4      | BE EF | 03    | 06 00 | FE D7        | 01 00  | 14 20 | 03 00        |
| MY MEMORY Save      | Set            | 1      | BE EF | 03    | 06 00 | F2 D6        | 01 00  | 15 20 | 00 00        |
|                     |                | 2      | BE EF | 03    | 06 00 | 62 D7        | 01 00  | 15 20 | 01 00        |
|                     |                | 3      | BE EF | 03    | 06 00 | 92 D7        | 01 00  | 15 20 | 02 00        |
|                     |                | 4      | BE EF | 03    | 06 00 | 02 D6        | 01 00  | 15 20 | 03 00        |

| Names            | Operation Type | Header      |       |    |       | Command Data |        |       |              |
|------------------|----------------|-------------|-------|----|-------|--------------|--------|-------|--------------|
|                  |                |             |       |    |       | CRC          | Action | Type  | Setting Code |
| PROGRESSIVE      | Set            | TURN OFF    | BE EF | 03 | 06 00 | 4A 72        | 01 00  | 07 22 | 00 00        |
|                  |                | TV          | BE EF | 03 | 06 00 | DA 73        | 01 00  | 07 22 | 01 00        |
|                  |                | FILM        | BE EF | 03 | 06 00 | 2A 73        | 01 00  | 07 22 | 02 00        |
|                  |                | Get         | BE EF | 03 | 06 00 | 79 72        | 02 00  | 07 22 | 00 00        |
| 3D-YCS           | Set            | TURN OFF    | BE EF | 03 | 06 00 | E6 70        | 01 00  | 0A 22 | 00 00        |
|                  |                | NORMAL      | BE EF | 03 | 06 00 | 76 71        | 01 00  | 0A 22 | 01 00        |
|                  |                | STILL IMAGE | BE EF | 03 | 06 00 | 86 71        | 01 00  | 0A 22 | 02 00        |
|                  |                | Get         | BE EF | 03 | 06 00 | D5 70        | 02 00  | 0A 22 | 00 00        |
| VIDEO NR         | Set            | LOW         | BE EF | 03 | 06 00 | 26 72        | 01 00  | 06 22 | 01 00        |
|                  |                | MIDDLE      | BE EF | 03 | 06 00 | D6 72        | 01 00  | 06 22 | 02 00        |
|                  |                | HIGH        | BE EF | 03 | 06 00 | 46 73        | 01 00  | 06 22 | 03 00        |
|                  |                | Get         | BE EF | 03 | 06 00 | 85 73        | 02 00  | 06 22 | 00 00        |
| ASPECT           | Set            | 4:3         | BE EF | 03 | 06 00 | 9E D0        | 01 00  | 08 20 | 00 00        |
|                  |                | 16:9        | BE EF | 03 | 06 00 | 0E D1        | 01 00  | 08 20 | 01 00        |
|                  |                | SMALL       | BE EF | 03 | 06 00 | FE D1        | 01 00  | 08 20 | 02 00        |
|                  |                | NORMAL      | BE EF | 03 | 06 00 | 5E DD        | 01 00  | 08 20 | 10 00        |
|                  |                | Get         | BE EF | 03 | 06 00 | AD D0        | 02 00  | 08 20 | 00 00        |
| OVER SCAN        |                | Get         | BE EF | 03 | 06 00 | 91 70        | 02 00  | 09 22 | 00 00        |
|                  |                | Increment   | BE EF | 03 | 06 00 | F7 70        | 04 00  | 09 22 | 00 00        |
|                  |                | Decrement   | BE EF | 03 | 06 00 | 26 71        | 05 00  | 09 22 | 00 00        |
| OVER SCAN Reset  |                | Execute     | BE EF | 03 | 06 00 | EC D9        | 06 00  | 27 70 | 00 00        |
| V POSITION       |                | Get         | BE EF | 03 | 06 00 | 0D 83        | 02 00  | 00 21 | 00 00        |
|                  |                | Increment   | BE EF | 03 | 06 00 | 6B 83        | 04 00  | 00 21 | 00 00        |
|                  |                | Decrement   | BE EF | 03 | 06 00 | BA 82        | 05 00  | 00 21 | 00 00        |
| V POSITION Reset |                | Execute     | BE EF | 03 | 06 00 | E0 D2        | 06 00  | 02 70 | 00 00        |
| H POSITION       |                | Get         | BE EF | 03 | 06 00 | F1 82        | 02 00  | 01 21 | 00 00        |
|                  |                | Increment   | BE EF | 03 | 06 00 | 97 82        | 04 00  | 01 21 | 00 00        |
|                  |                | Decrement   | BE EF | 03 | 06 00 | 46 83        | 05 00  | 01 21 | 00 00        |
| H POSITION Reset |                | Execute     | BE EF | 03 | 06 00 | 1C D3        | 06 00  | 03 70 | 00 00        |
| H PHASE          |                | Get         | BE EF | 03 | 06 00 | 49 83        | 02 00  | 03 21 | 00 00        |
|                  |                | Increment   | BE EF | 03 | 06 00 | 2F 83        | 04 00  | 03 21 | 00 00        |
|                  |                | Decrement   | BE EF | 03 | 06 00 | FE 82        | 05 00  | 03 21 | 00 00        |
| H SIZE           |                | Get         | BE EF | 03 | 06 00 | B5 82        | 02 00  | 02 21 | 00 00        |
|                  |                | Increment   | BE EF | 03 | 06 00 | D3 82        | 04 00  | 02 21 | 00 00        |
|                  |                | Decrement   | BE EF | 03 | 06 00 | 02 83        | 05 00  | 02 21 | 00 00        |
| H SIZE Reset     |                | Execute     | BE EF | 03 | 06 00 | 68 D2        | 06 00  | 04 70 | 00 00        |
| AUTO ADJUST      |                | Execute     | BE EF | 03 | 06 00 | 91 D0        | 06 00  | 0A 20 | 00 00        |



RS-232C Communication (continued)

| Names            | Operation Type | Header     |       |       |       | Command Data |       |              |       |
|------------------|----------------|------------|-------|-------|-------|--------------|-------|--------------|-------|
|                  |                |            |       |       | CRC   | Action       | Type  | Setting Code |       |
| COLOR SPACE      | Set            | AUTO       | BE EF | 03    | 06 00 | 0E 72        | 01 00 | 04 22        | 00 00 |
|                  |                | RGB        | BE EF | 03    | 06 00 | 9E 73        | 01 00 | 04 22        | 01 00 |
|                  |                | SMPTE240   | BE EF | 03    | 06 00 | 6E 73        | 01 00 | 04 22        | 02 00 |
|                  |                | REC709     | BE EF | 03    | 06 00 | FE 72        | 01 00 | 04 22        | 03 00 |
|                  | REC601         | BE EF      | 03    | 06 00 | CE 70 | 01 00        | 04 22 | 04 00        |       |
|                  | Get            | BE EF      | 03    | 06 00 | 3D 72 | 02 00        | 04 22 | 00 00        |       |
| COMPONENT        | Set            | COMPONENT  | BE EF | 03    | 06 00 | 4A D7        | 01 00 | 17 20        | 00 00 |
|                  |                | SCART RGB  | BE EF | 03    | 06 00 | DA D6        | 01 00 | 17 20        | 01 00 |
|                  | Get            | BE EF      | 03    | 06 00 | 79 D7 | 02 00        | 17 20 | 00 00        |       |
| VIDEO FORMAT     | Set            | AUTO       | BE EF | 03    | 06 00 | 9E 75        | 01 00 | 00 22        | 0A 00 |
|                  |                | NTSC       | BE EF | 03    | 06 00 | FE 71        | 01 00 | 00 22        | 04 00 |
|                  |                | PAL        | BE EF | 03    | 06 00 | 6E 70        | 01 00 | 00 22        | 05 00 |
|                  |                | SECAM      | BE EF | 03    | 06 00 | 6E 75        | 01 00 | 00 22        | 09 00 |
|                  |                | NTSC4.43   | BE EF | 03    | 06 00 | 5E 72        | 01 00 | 00 22        | 02 00 |
|                  |                | M-PAL      | BE EF | 03    | 06 00 | FE 74        | 01 00 | 00 22        | 08 00 |
|                  | N-PAL          | BE EF      | 03    | 06 00 | 0E 71 | 01 00        | 00 22 | 07 00        |       |
| Get              | BE EF          | 03         | 06 00 | 0D 73 | 02 00 | 00 22        | 00 00 |              |       |
| DVI              | Set            | DVD        | BE EF | 03    | 06 00 | 3E D9        | 01 00 | 20 20        | 00 00 |
|                  |                | COMPUTER   | BE EF | 03    | 06 00 | AE D8        | 01 00 | 20 20        | 01 00 |
|                  | Get            | BE EF      | 03    | 06 00 | 0D D9 | 02 00        | 20 20 | 00 00        |       |
| KEYSTONE V       | Get            | BE EF      | 03    | 06 00 | B9 D3 | 02 00        | 07 20 | 00 00        |       |
|                  | Increment      | BE EF      | 03    | 06 00 | DF D3 | 04 00        | 07 20 | 00 00        |       |
|                  | Decrement      | BE EF      | 03    | 06 00 | 0E D2 | 05 00        | 07 20 | 00 00        |       |
| KEYSTONE V Reset | Execute        | BE EF      | 03    | 06 00 | 08 D0 | 06 00        | 0C 70 | 00 00        |       |
| KEYSTONE H       | Get            | BE EF      | 03    | 06 00 | E9 D0 | 02 00        | 0B 20 | 00 00        |       |
|                  | Increment      | BE EF      | 03    | 06 00 | 8F d0 | 04 00        | 0B 20 | 00 00        |       |
|                  | Decrement      | BE EF      | 03    | 06 00 | 5E D1 | 05 00        | 0B 20 | 00 00        |       |
| KEYSTONE H Reset | Execute        | BE EF      | 03    | 06 00 | 98 D8 | 06 00        | 20 70 | 00 00        |       |
| WHISPER          | Set            | NORMAL     | BE EF | 03    | 06 00 | 3B 23        | 01 00 | 00 33        | 00 00 |
|                  |                | WHISPER    | BE EF | 03    | 06 00 | AB 22        | 01 00 | 00 33        | 01 00 |
|                  | Get            | BE EF      | 03    | 06 00 | 08 23 | 02 00        | 00 33 | 00 00        |       |
| MIRROR           | Set            | NORMAL     | BE EF | 03    | 06 00 | C7 D2        | 01 00 | 01 30        | 00 00 |
|                  |                | H:INVERT   | BE EF | 03    | 06 00 | 57 D3        | 01 00 | 01 30        | 01 00 |
|                  |                | V:INVERT   | BE EF | 03    | 06 00 | A7 D3        | 01 00 | 01 30        | 02 00 |
|                  |                | H&V:INVERT | BE EF | 03    | 06 00 | 37 D2        | 01 00 | 01 30        | 03 00 |
|                  | Get            | BE EF      | 03    | 06 00 | F4 D2 | 02 00        | 01 30 | 00 00        |       |
| VOLUME           | Get            | BE EF      | 03    | 06 00 | 31 D3 | 02 00        | 01 20 | 00 00        |       |
|                  | Increment      | BE EF      | 03    | 06 00 | 57 D3 | 04 00        | 01 20 | 00 00        |       |
|                  | Decrement      | BE EF      | 03    | 06 00 | 86 D2 | 05 00        | 01 20 | 00 00        |       |

RS-232C Communication (continued)

| Names                    | Operation Type | Header     |       |       |       | Command Data |        |       |              |
|--------------------------|----------------|------------|-------|-------|-------|--------------|--------|-------|--------------|
|                          |                |            |       |       |       | CRC          | Action | Type  | Setting Code |
| MUTE                     | Set            | TURN OFF   | BE EF | 03    | 06 00 | 46 D3        | 01 00  | 02 20 | 00 00        |
|                          |                | TURN ON    | BE EF | 03    | 06 00 | D6 D2        | 01 00  | 02 20 | 01 00        |
|                          | Get            | BE EF      | 03    | 06 00 | 75 D3 | 02 00        | 02 20  | 00 00 |              |
| STEREO                   | Set            | MONO       | BE EF | 03    | 06 00 | 92 D4        | 01 00  | 1D 20 | 00 00        |
|                          |                | STEREO     | BE EF | 03    | 06 00 | 02 D5        | 01 00  | 1D 20 | 01 00        |
|                          | Get            | BE EF      | 03    | 06 00 | A1 D4 | 02 00        | 1D 20  | 00 00 |              |
| IR REMOTE Front          | Set            | Off        | BE EF | 03    | 06 00 | FF 32        | 01 00  | 00 26 | 00 00        |
|                          |                | On         | BE EF | 03    | 06 00 | 6F 33        | 01 00  | 00 26 | 01 00        |
|                          | Get            | BE EF      | 03    | 06 00 | CC 32 | 02 00        | 00 26  | 00 00 |              |
| IR REMOTE Top            | Set            | Off        | BE EF | 03    | 06 00 | 47 33        | 01 00  | 02 26 | 00 00        |
|                          |                | On         | BE EF | 03    | 06 00 | D7 32        | 01 00  | 02 26 | 01 00        |
|                          | Get            | BE EF      | 03    | 06 00 | 74 33 | 02 00        | 02 26  | 00 00 |              |
| LANGUAGE                 | Set            | ENGLISH    | BE EF | 03    | 06 00 | F7 D3        | 01 00  | 05 30 | 00 00        |
|                          |                | FRANÇAIS   | BE EF | 03    | 06 00 | 67 D2        | 01 00  | 05 30 | 01 00        |
|                          |                | DEUTSCH    | BE EF | 03    | 06 00 | 97 D2        | 01 00  | 05 30 | 02 00        |
|                          |                | ESPAÑOL    | BE EF | 03    | 06 00 | 07 D3        | 01 00  | 05 30 | 03 00        |
|                          |                | ITALIANO   | BE EF | 03    | 06 00 | 37 D1        | 01 00  | 05 30 | 04 00        |
|                          |                | NORSK      | BE EF | 03    | 06 00 | A7 D0        | 01 00  | 05 30 | 05 00        |
|                          |                | NEDERLANDS | BE EF | 03    | 06 00 | 57 D0        | 01 00  | 05 30 | 06 00        |
|                          |                | PORTUGUÊS  | BE EF | 03    | 06 00 | C7 D1        | 01 00  | 05 30 | 07 00        |
|                          |                | 日本語        | BE EF | 03    | 06 00 | 37 D4        | 01 00  | 05 30 | 08 00        |
|                          |                | 简体中文       | BE EF | 03    | 06 00 | A7 D5        | 01 00  | 05 30 | 09 00        |
|                          |                | 한글         | BE EF | 03    | 06 00 | 57 D5        | 01 00  | 05 30 | 0A 00        |
|                          |                | SVENSKA    | BE EF | 03    | 06 00 | C7 D4        | 01 00  | 05 30 | 0B 00        |
|                          |                | РУССКИЙ    | BE EF | 03    | 06 00 | F7 D6        | 01 00  | 05 30 | 0C 00        |
|                          |                | SUOMI      | BE EF | 03    | 06 00 | 67 D7        | 01 00  | 05 30 | 0D 00        |
|                          | POLSKI         | BE EF      | 03    | 06 00 | 97 D7 | 01 00        | 05 30  | 0E 00 |              |
| TÜRKÇE                   | BE EF          | 03         | 06 00 | 07 D6 | 01 00 | 05 30        | 0F 00  |       |              |
| 繁體中文                     | BE EF          | 03         | 06 00 | 37 DE | 01 00 | 05 30        | 10 00  |       |              |
| Get                      | BE EF          | 03         | 06 00 | C4 D3 | 02 00 | 05 30        | 00 00  |       |              |
| MENU POSITION H          | Get            | BE EF      | 03    | 06 00 | 04 D7 | 02 00        | 15 30  | 00 00 |              |
|                          | Increment      | BE EF      | 03    | 06 00 | 62 D7 | 04 00        | 15 30  | 00 00 |              |
|                          | Decrement      | BE EF      | 03    | 06 00 | B3 D6 | 05 00        | 15 30  | 00 00 |              |
| MENU POSITION H<br>Reset | Execute        | BE EF      | 03    | 06 00 | DC C6 | 06 00        | 43 70  | 00 00 |              |
| MENU POSITION V          | Get            | BE EF      | 03    | 06 00 | 40 D7 | 02 00        | 16 30  | 00 00 |              |
|                          | Increment      | BE EF      | 03    | 06 00 | 26 D7 | 04 00        | 16 30  | 00 00 |              |
|                          | Decrement      | BE EF      | 03    | 06 00 | F7 D6 | 05 00        | 16 30  | 00 00 |              |
| MENU POSITION V<br>Reset | Execute        | BE EF      | 03    | 06 00 | A8 C7 | 06 00        | 44 70  | 00 00 |              |

| Names            | Operation Type | Header              |       |       |       | Command Data |        |       |              |
|------------------|----------------|---------------------|-------|-------|-------|--------------|--------|-------|--------------|
|                  |                |                     |       |       |       | CRC          | Action | Type  | Setting Code |
| OSD BRIGHT       | Get            | BE EF               | 03    | 06 00 | A8 D5 | 02 00        | 18 30  | 00 00 |              |
|                  | Increment      | BE EF               | 03    | 06 00 | CE D5 | 04 00        | 18 30  | 00 00 |              |
|                  | Decrement      | BE EF               | 03    | 06 00 | 1F D4 | 05 00        | 18 30  | 00 00 |              |
| BLANK            | Set            | My Screen           | BE EF | 03    | 06 00 | FB CA        | 01 00  | 00 30 | 20 00        |
|                  |                | ORIGINAL            | BE EF | 03    | 06 00 | FB E2        | 01 00  | 00 30 | 40 00        |
|                  |                | BLUE                | BE EF | 03    | 06 00 | CB D3        | 01 00  | 00 30 | 03 00        |
|                  |                | WHITE               | BE EF | 03    | 06 00 | 6B D0        | 01 00  | 00 30 | 05 00        |
|                  |                | BLACK               | BE EF | 03    | 06 00 | 9B D0        | 01 00  | 00 30 | 06 00        |
|                  | Get            | BE EF               | 03    | 06 00 | 08 D3 | 02 00        | 00 30  | 00 00 |              |
| BLANK On/Off     | Set            | TURN OFF            | BE EF | 03    | 06 00 | FB D8        | 01 00  | 20 30 | 00 00        |
|                  |                | TURN ON             | BE EF | 03    | 06 00 | 6B D9        | 01 00  | 20 30 | 01 00        |
|                  | Get            | BE EF               | 03    | 06 00 | C8 D8 | 02 00        | 20 30  | 00 00 |              |
| START UP         | Set            | My Screen           | BE EF | 03    | 06 00 | CB CB        | 01 00  | 04 30 | 20 00        |
|                  |                | ORIGINAL            | BE EF | 03    | 06 00 | 0B D2        | 01 00  | 04 30 | 00 00        |
|                  |                | TURN OFF            | BE EF | 03    | 06 00 | 9B D3        | 01 00  | 04 30 | 01 00        |
|                  | Get            | BE EF               | 03    | 06 00 | 38 D2 | 02 00        | 04 30  | 00 00 |              |
| My Screen LOCK   | Set            | TURN OFF            | BE EF | 03    | 06 00 | 3B EF        | 01 00  | C0 30 | 00 00        |
|                  |                | TURN ON             | BE EF | 03    | 06 00 | AB EE        | 01 00  | C0 30 | 01 00        |
|                  | Get            | BE EF               | 03    | 06 00 | 08 EF | 02 00        | C0 30  | 00 00 |              |
| Message          | Set            | TURN OFF            | BE EF | 03    | 06 00 | 8F D6        | 01 00  | 17 30 | 00 00        |
|                  |                | TURN ON             | BE EF | 03    | 06 00 | 1F D7        | 01 00  | 17 30 | 01 00        |
|                  | Get            | BE EF               | 03    | 06 00 | BC D6 | 02 00        | 17 30  | 00 00 |              |
| ONE TOUCH        | Set            | KEYSTONE V TURN OFF | BE EF | 03    | 06 00 | 16 D0        | 01 00  | 0E 20 | 00 00        |
|                  |                | KEYSTONE V TURN ON  | BE EF | 03    | 06 00 | 86 D1        | 01 00  | 0E 20 | 01 00        |
|                  | Get            | BE EF               | 03    | 06 00 | 25 D0 | 02 00        | 0E 20  | 00 00 |              |
| AUTO KEYSTONE V  | EXECUTE        | BE EF               | 03    | 06 00 | E5 D1 | 06 00        | 0D 20  | 00 00 |              |
| AUTO SEARCH      | Set            | TURN OFF            | BE EF | 03    | 06 00 | B6 D6        | 01 00  | 16 20 | 00 00        |
|                  |                | TURN ON             | BE EF | 03    | 06 00 | 26 D7        | 01 00  | 16 20 | 01 00        |
|                  | Get            | BE EF               | 03    | 06 00 | 85 D6 | 02 00        | 16 20  | 00 00 |              |
| AUTO POWER OFF   | Get            | BE EF               | 03    | 06 00 | 08 86 | 02 00        | 10 31  | 00 00 |              |
|                  | Increment      | BE EF               | 03    | 06 00 | 6E 86 | 04 00        | 10 31  | 00 00 |              |
|                  | Decrement      | BE EF               | 03    | 06 00 | BF 87 | 05 00        | 10 31  | 00 00 |              |
| LAMP TIME        | Get            | BE EF               | 03    | 06 00 | C2 FF | 02 00        | 90 10  | 00 00 |              |
| LAMP TIME Reset  | Execute        | BE EF               | 03    | 06 00 | 58 DC | 06 00        | 30 70  | 00 00 |              |
| FILTER TIME      | Get            | BE EF               | 03    | 06 00 | C2 F0 | 02 00        | A0 10  | 00 00 |              |
| FILER TIME Reset | Execute        | BE EF               | 03    | 06 00 | 98 C6 | 06 00        | 40 70  | 00 00 |              |
| MAGNIFY          | Get            | BE EF               | 03    | 06 00 | 7C D2 | 02 00        | 07 30  | 00 00 |              |
|                  | Increment      | BE EF               | 03    | 06 00 | 1A D2 | 04 00        | 07 30  | 00 00 |              |
|                  | Decrement      | BE EF               | 03    | 06 00 | CB D3 | 05 00        | 07 30  | 00 00 |              |
| FREEZE           | Set            | NORMAL              | BE EF | 03    | 06 00 | 83 D2        | 01 00  | 02 30 | 00 00        |
|                  |                | FREEZE              | BE EF | 03    | 06 00 | 13 D3        | 01 00  | 02 30 | 01 00        |
|                  | Get            | BE EF               | 03    | 06 00 | B0 D2 | 02 00        | 02 30  | 00 00 |              |

# ***DUKANE CORPORATION***

## **FIVE-YEAR LIMITED WARRANTY**

This Dukane projector is warranted to the original purchaser for a period of five (5) years from the original purchase date – in normal operating conditions – against defects in material and workmanship . DUKANE CORPORATION EXPRESSLY DISCLAIMS ALL OTHER WARRANTIES OF MERCHANTABILITY AND FITNESS FOR A PARTICULAR PURPOSE.

DURING THE WARRANTY PERIOD, DUKANE CORPORATION'S LIABILITY FOR ANY DEFECTIVE PRODUCT (except for the lamp, which is subject to whatever warranties the manufacturer may provide) IS LIMITED TO THE REPAIR OR REPLACEMENT OF PRODUCT AT DUKANE CORPORATION'S OPTION. REPLACEMENT PRODUCTS MAY BE NEW OR USED (used units will not exceed hours of defective unit). The following are not covered by the limited warranty and Dukane Corporation shall not be liable for:

1. Any product which is not distributed in the U.S.A. or Canada by Dukane Corporation or an authorized dealer.
2. Normal decrease in lamp light output over time.
3. Damage, deterioration or malfunction resulting from:
  - Accident, misuse, abuse, neglect, improper ventilation, fire, dust, smoke, water, lighting or other acts of nature, unauthorized product modification, or failure to follow instructions supplied with the product (including proper maintenance of air filters).
  - Repair or attempted repair by anyone other than a Dukane Corporation authorized service center.
  - Any shipment of product (claims must be presented to the carrier).
  - Removal or installation of the product.
  - Any other causes which do not relate to a product defect.
  - Use of the product beyond normal operating conditions. Normal operating conditions are defined as product use not in excess of 8 hours per day and 260 days per year.
4. Cartons, carry cases, shipping cases, batteries, or any accessories used in connection with the product.
5. Service required as a result of third party components.
6. Product used as commercial rental units

Dukane corporation will pay labor and material expenses for covered items, but Dukane Corporation will not pay for the following:

1. Removal or installation charges.
2. Cost of technical adjustment, set-up, maintenance, or adjustment of user controls.
3. Payment of shipping and related charges incurred in returning the product for warranty repair.

Dukane Corporation disclaims all liability for incidental or consequential damage of any kind, including all damages arising out of any interruptions in operation of the product and all damages to software.

No person, firm, or representative is authorized to assume any obligation or to make any warranty on behalf of the Dukane Corporation other than as stated above.

Audio Visual Products

Dukane Corporation  
Audio Visual Products Division  
2900 Dukane Drive  
St. Charles, IL 60174-3395  
E-mail: [avsales@dukcorp.com](mailto:avsales@dukcorp.com)

Phone: (630) 762-4040  
Orders: (800) 676-2485  
Fax: (630) 584-5156  
Parts & Service: (800) 676-2487  
Fax: (630) 584-0984

***DUKANE***

Part # 401-8915-00